

## About This Guide

Thank you for choosing this Enterprise IP Phone which is especially designed for power users in the office environment. It features fashionable and sleek design, abundant telephony applications, broad interoperability with the popular 3<sup>rd</sup> party VoIP products, fulfilling the VoIP deployment needs from enterprise and ITSP.

In this User Guide, you will find everything you need to quickly use your new phone. Be sure to verify with your system administrator that your network is prepared for configuring your IP phone. As well, be sure to read the Packing List section in this guide before you set up and use the phone.

### Declaration of Conformity



Hereby, it's declared that this phone is in conformity with the essential requirements and other relevant provisions of the CE, FCC.

### CE Mark Warning

This is a class B device, in a domestic environment; this product may cause radio interference, in which case the user may be required to take adequate measures.

### WEEE Warning



To avoid the potential effects on the environment and human health as a result of the presence of hazardous substances in electrical and electronic equipment, end users of electrical and electronic equipment should understand the meaning of the crossed-out wheeled bin symbol. Do not dispose of WEEE as unsorted municipal waste and have to collect such WEEE separately.

# Contents

## **Getting Started..... - 1 -**

Packing List .....	- 1 -
Assembling the Phone.....	- 3 -
Configuration and Registration .....	- 4 -
Configuring via Web Page .....	- 4 -
Configuring via keypad.....	- 6 -

## **Overview..... - 7 -**

Keypad Instruction.....	- 7 -
LED Instruction.....	- 8 -
Icon Instruction .....	- 9 -
User Interface.....	- 10 -

## **Customizing Your Phone..... - 13 -**

General Settings .....	- 13 -
Phone Status .....	- 13 -
Language.....	- 13 -
Time and Date .....	- 14 -
Keypad Lock .....	- 16 -
Audio Settings.....	- 18 -
Volume .....	- 18 -
Ring Tones .....	- 18 -
Codec Selection.....	- 20 -
Contact Management .....	- 21 -
Edit/Add/Delete Contact .....	- 21 -
Import/Export Contact list.....	- 24 -
Blacklist .....	- 25 -
Remote Phone Book.....	- 26 -
Broadsoft.....	- 27 -
LDAP .....	- 27 -
Other Settings.....	- 28 -
Key as Send.....	- 28 -
Hot Line .....	- 29 -
Anonymous call .....	- 30 -
Auto Redial .....	- 31 -
Auto Answer .....	- 32 -
Missed call log .....	- 33 -
Broadsoft Call Log.....	- 33 -

Logo Customization .....	- 34 -
Programmable Key .....	- 35 -
Softkey Layout .....	- 35 -
Live Dialpad.....	- 36 -
Replace Rule .....	- 37 -
Dial Now .....	- 37 -
Area Code .....	- 38 -
Block Out.....	- 39 -
Feature Synchronisation.....	- 40 -
Push XML.....	- 41 -
WatchDog.....	- 42 -
Action URL/URI.....	- 43 -

## **Using the Basic Call Functions..... - 46 -**

Making a call.....	- 46 -
Call Devices .....	- 46 -
Call Methods .....	- 46 -
Password dial .....	- 48 -
Call Completion .....	- 49 -
Answering a call.....	- 50 -
Answering an incoming call.....	- 50 -
Denying an incoming call .....	- 50 -
DND.....	- 50 -
Call Forward .....	- 50 -
Intercom .....	- 51 -
During an Active Call .....	- 52 -
Mute .....	- 52 -
Call Hold.....	- 52 -
Call Waiting .....	- 53 -
Call Transfer.....	- 53 -
3-way Conference .....	- 54 -
Network Conference .....	- 54 -
HuaWei ATS Conference .....	- 55 -
Message.....	- 57 -
Voicemail .....	- 57 -
SMS.....	- 59 -

## **Using the Advanced Phone Functions ..... - 61 -**

Account Setting.....	- 61 -
TLS .....	- 62 -
DNS-SRV .....	- 62 -
Network Setting .....	- 63 -
PC Port Setting.....	- 63 -
VLAN Setting .....	- 64 -

LLDP.....	- 65 -
HTTPS .....	- 66 -
Maintenance Tasks .....	- 67 -
Administrator Mode .....	- 67 -
Administrator/User Password .....	- 67 -
Reboot .....	- 68 -
Reset to Factory .....	- 68 -
Firmware Update.....	- 69 -
Decryption.....	- 70 -
Zero-sp-touch .....	- 71 -
System Log Export.....	- 72 -
PCAP Trace Export .....	- 72 -
802.1X.....	- 73 -
DSS keys Configuration.....	- 73 -
Conference .....	- 74 -
Forward .....	- 74 -
Transfer .....	- 75 -
Hold.....	- 75 -
DND.....	- 75 -
Redial .....	- 75 -
Call Return .....	- 76 -
SMS.....	- 76 -
Pick Up.....	- 76 -
Call Park.....	- 76 -
DTMF .....	- 77 -
Voice Mail .....	- 77 -
Speed Dial.....	- 77 -
Intercom .....	- 78 -
Line .....	- 78 -
BLF .....	- 78 -
URL.....	- 79 -
Group Listening .....	- 79 -
Public Hold .....	- 79 -
Private Hold .....	- 79 -
Shared Line .....	- 80 -
XML Group.....	- 80 -
Group Pick up .....	- 80 -
Paging .....	- 81 -
Record .....	- 81 -
Xml Browser .....	- 81 -
Hot Desking .....	- 82 -
URL Record .....	- 82 -
LDAP .....	- 83 -
BLF List .....	- 83 -

Prefix.....	- 83 -
Zero-sp-touch .....	- 84 -
ACD .....	- 84 -
Local Group .....	- 84 -
Broadsoft Group.....	- 85 -
Tone Settings.....	- 85 -
Voice .....	- 86 -
Ring.....	- 87 -
<b>Trouble Shooting.....</b>	<b>- 88 -</b>

# Getting Started

## Packing List

The following components are included in your package:

- Enterprise IP Phone

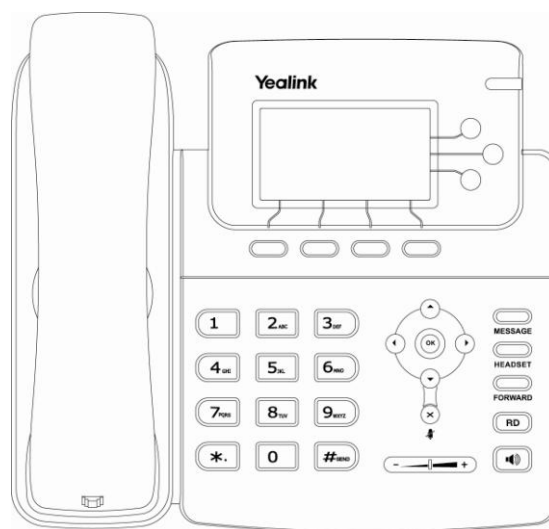

- Phone Stand



- Power Adapter

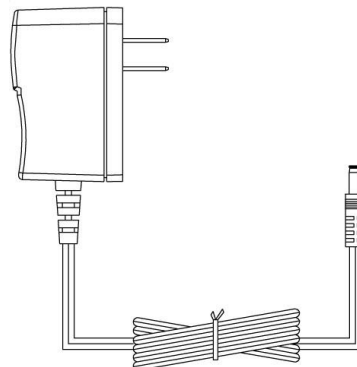

- Handset & Handset Cord

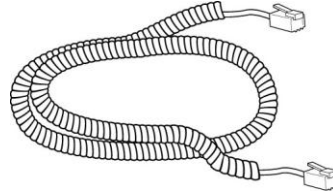

- Ethernet Cable

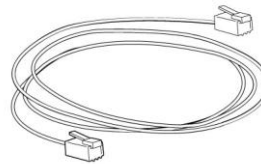

- Quick Installation Guide & Quick Reference

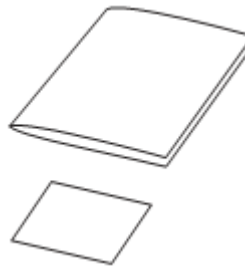

- CD Content



Check this list before installation to ensure that you have received each item. If you are missing any items, contact your IP phone reseller.

## Assembling the Phone

This section introduces how to assemble the phone with the components in the packing list:

- Attach the stand;
- Connect Handset and Headset;
- Connect Network and Power.

### 1) Attach the Stand, as shown below:

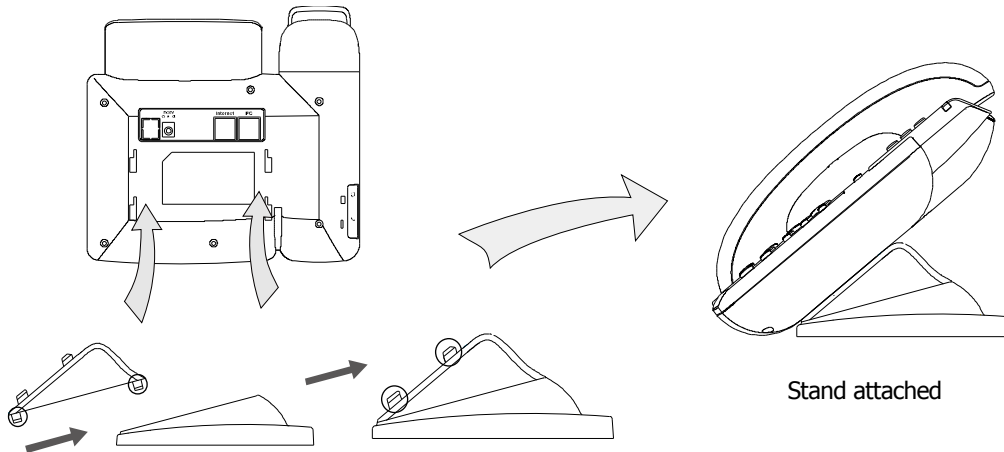

### 2) Connect Handset and Headset, as shown below:

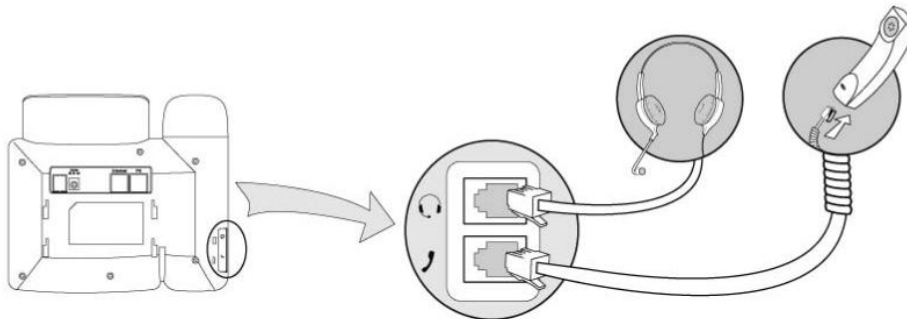
**Note:**

Headset is not provided in the packing list. Please contact your distributor for more information.

### 3) Connect Network and Power

There are two ways for network and power source connections. You can either connect the phone to the AC Power directly using the power adapter or to a PoE compliant switch or hub. Your system administrator will advise you on which one to use.

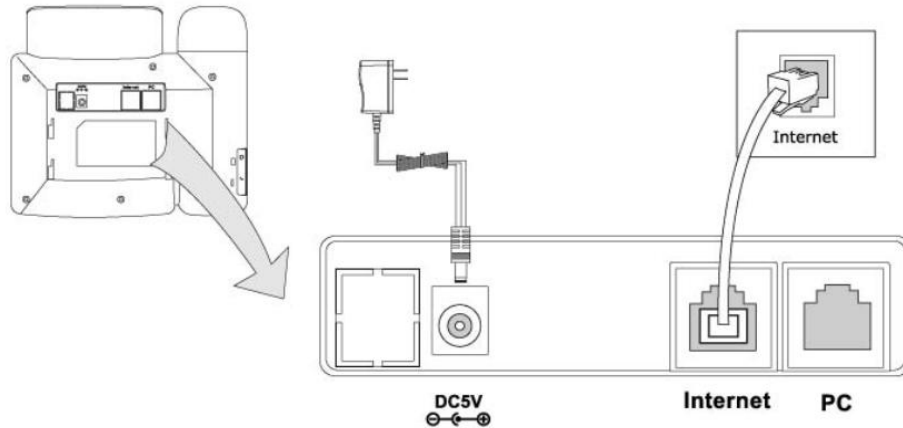

**Note:**

1. If inline power is provided, do not install AC adapter. Make sure the Ethernet cable and switch/hub is PoE compliant.
2. The Internet Port can be also connected to Hub/Switch/IP PBX or other internet devices.

The phone can also share the network connection with other network devices such as PC. Connect the phone's PC port and computer's Network Port together using an Ethernet cable, shown as below:

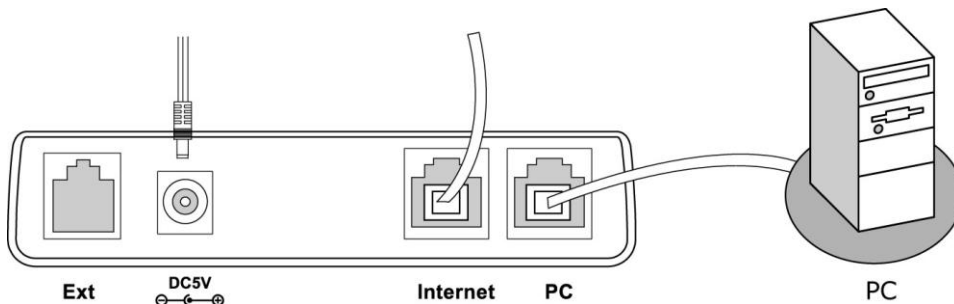

## Configuration and Registration

If you are administrator, you need to do some simple configuration to make the phone work. If not, please contact your internet administrator or service provider for more details.

### Configuring via Web Page

Press OK button on the keypad of the phone to enter the status page and find out the IP address of IP phone. Enter it (for example <http://192.168.3.35>) into the address bar of web browser. The default administrator's login name and password are **admin/admin**. The default user's login name and password are **user/user**.

**Note:**

Please locate your PC in the same network segment of IP phone (192.168.3.X) to access the web configuration page. Please consult your system administrator for help.

**Network Settings**

Choose Network->Internet Port (WAN) .

**DHCP:** Under the default situation the phone attempts to contact a DHCP Server in your network in order to obtain its valid network settings, e.g. IP address, sub mask, gateway, DNS server, etc.

**Static IP Address:** If your phone cannot contact a DHCP Server for any reason, you need to enter the network settings manually via Static IP Address. Please contact your internet administrator for more details.

**PPPoE:** If you are using the xDSL Modem, you can connect your phone to the internet via PPPoE mode. Please contact your ISP for the User **Name** and **Password** for internet access.

**Note:**

Using the wrong network parameters may result in inaccessibility of your phone and may also have an impact on your network performance. Please contact your network administrator.

**Account Settings**

The phone attempts to register to the SIP server using the parameters obtained by initialization.

Choose Account, you will find the following parameters:

Field	Description
<i>Register Status</i>	It shows the register status of the phone.
<i>Account Active</i>	You can choose on/off to enable/disable the account respectively.
<i>Label</i>	The name showing on the LCD of current device.
<i>Display Name</i>	The local phone name showing on the other phone when calling.
<i>Register Name</i>	Register name provided by ISP.
<i>User Name</i>	User account information, provided by ISP.
<i>Password</i>	Account password provided by ISP.
<i>SIP Server</i>	SIP server address provided by ISP.

When you have finished the Network and Account Setting configuration, the Register Status Icons will show in the idle screen:



Registering



Registered successfully



Register failed

When all accounts register fail, phone will display "No Service" by default.

When the phone reboot, it will register automatically. If many phones register at the same time, this will affect the server, the users can set the register power up time so that the phone will random register automatically within the set time.

Setting the power up time via web interface:

Choose Network->Advanced-> Registration random, enter the time in the field.

**Note:**

Should the IP PBX (SIP registrar) require an authentication, you will be prompted to enter the correct password. Make sure you are using the appropriate input method or enter the password via the web user interface.

### Configuring via keypad

**Network Settings:** Press Menu->Settings->Advanced Settings, enter the password, and choose Network ->WAN Port /PC Port /VLAN/Webserver Type/802.1x Settings Option to enter the internet relating configuration page.

**Account Settings:** Press Menu->Settings->Advanced Settings, enter the password, and choose Accounts->Enter to configure the account settings.

You can refer to the above "Configuring via Web Page" for the parameter details.

# Overview

## Keypad Instruction

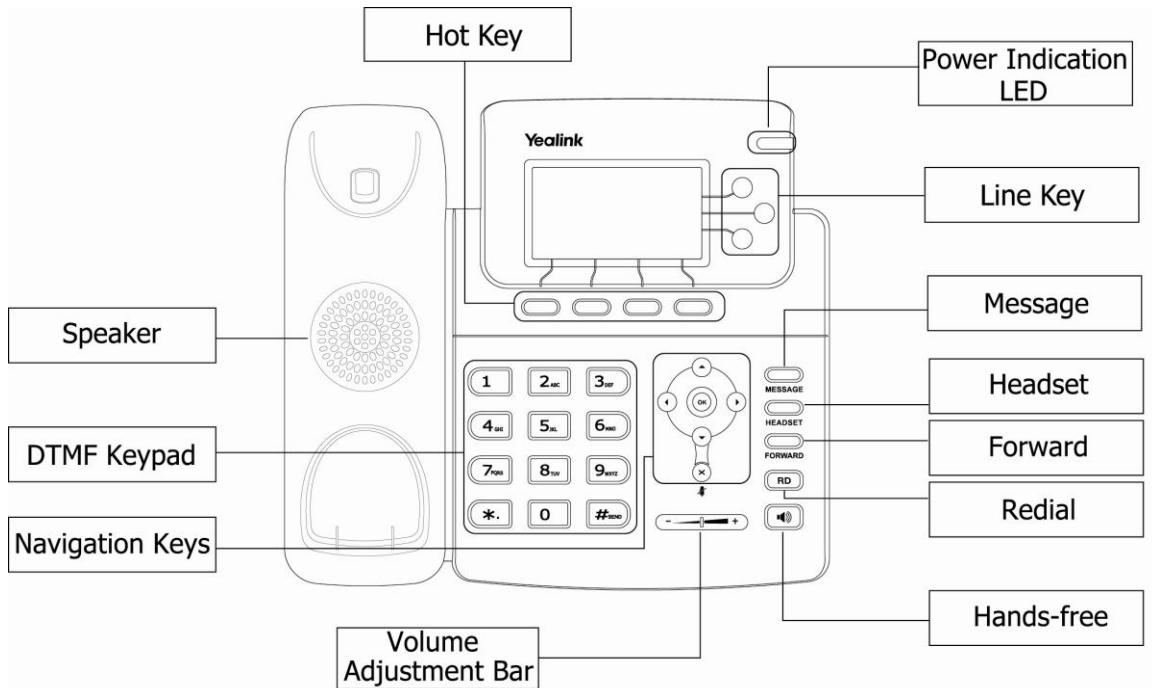

You can check the following list which introduces the IP phone's keypad in details:

### Power Indication LED

It will show the power status, it will be on if the phone is powered, off if the phone is not powered, and blink when someone calls in or there is a call on mute.

### Hot Key

The screen will display labels for these keys, to identify their context-sensitive functions and you can custom softkeys under different status.

### Line Key

These buttons are used to active up to the three user accounts.



### DTMF Keypad

Use the DTMF hard keys to enter numbers, letters and special characters. Depending on the selected input mode, you can enter digits, lower / upper case or special characters.

### Navigation Keys

Use the navigation keys to navigate in the display menus and confirm and cancel

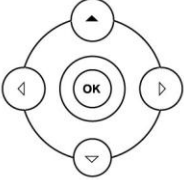
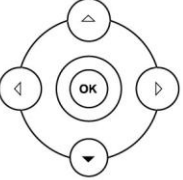
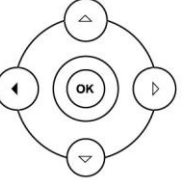
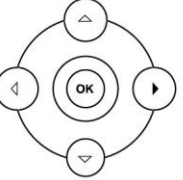
actions.

Cancel	Up	Down	Left	Right	Confirm
					

### Audio Device Control Keys

Use the audio device control keys to perform the following actions depending on your phone type:

: Adjust the volume of the handset, headset, speaker and ring tone;

: Allows for hands-free communication during calls;  
Press to switch to the Group Listening mode.

 HEADSET: Place and receive calls through an optionally connected headset.

: Mute audio transmission locally during calls;

### Hard Feature Keys

 MESSAGE: Allow users to access the Voice Mail interface directly;

 FORWARD: Forward the current call to third party;  
When the phone is idle, press to enter the forward configuration page.

: Press to enter the Dialed Calls interface, then choose a record to dial out.

## LED Instruction

Table 1 Line Keys

LED Status	Description
Steady green	The account is active
Blinking green	There is an incoming call to the account, or there is a call on hold status
off	The phone is in idle status whatever registered/ unregistered

Table 2 Line Keys set to BLF

LED Status	Description
Steady green	The monitored account is in idle status
Fast blinking green	There is an incoming call to the monitored account
Slow blinking green	The monitored account is on an conversation
Off	It is not active as BLF

Table 3 Power Indication LED











LED Status	Description
Steady green	Power on
Blinking green	There is incoming call to the device, or there is call on mute
off	Power off

















Table 4 Line Keys set to BLA

LED Status	Description
Steady green	All of the members are in idle status
Slow blinking green	Some part(s) is seizing the line/ ring-back/ under the private hold status.
Fast blinking green	Some part(s) is ringing /on the phone / under the public hold status or all of the parts press hold.
Off	It is inactive as BLA

## Icon Instruction

The IP Phone displays different kinds of icons on its LCD, you can refer to the following table for their meanings:

Icon	Description
	Flashes when the internet is disconnected
	Account register failed
	Account registering
	Account register successful
	Missed calls
	Call in
	Call out
	Input Method: all letters and numbers
	Input Method: numbers
	Input Method: multi-lingual letters in lower case

	Input Method: multi-lingual letters in upper case
	Call mute
	Call hold
	Voicemail
	SMS
	Call forward
	DND(Do Not Disturb)
	Auto answer
	In handset mode
	In headset mode
	In speaker mode
	The recording session cannot be started
	The recording cannot be stopped
	Probably the recording box is full
	This call cannot be recorded.
	The recording session is successfully started

## User Interface

There are two ways to customize specific options on your phones:

1. Using keypad and display on the phone;
2. Using Web user interface in an Internet browser from your PC; please refer to "Configuration and Registration" to get into the Web interface.

In many instances, it is possible to use both the user interfaces to operate the phone and change settings; some, however, are only possible via a phone or web user interface. Please refer to the following table for differences:

Phone Options	Phone UI	Web UI
<b>Status</b>		
--IP		
--MAC		
--Firmware	√	√
--Network		
--Phone		
--Accounts		
<b>Call Features</b>		

--Call Forward	√	√
--Call Waiting	√	√
--DSS Keys	√	
--Key as Send	√	
--Hot Line	√	
--Anonymous Call	√	
--Auto Redial Settings	√	
--Dial Plan		
--Tones		
--DND Code	√	
--ReDialTone		
--Emergency		
--BusyToneDelay		
--Return code when refuse		
--Return code when DND		
--Intercom	√	
--Call Completion	√	
<b>Basic Phone Functions</b>		
--Language	√	√
--Time & Date	√	√
--Ring Tone	√	√
--Phone Volume	√	
--Logo Customization		√
<b>Advanced Phone Functions</b>		
--Accounts	√	
--Network	√	
--Voice		
--Codecs		
--Echo Cancellation etc		
--Reset to factory	√	√
--Set admin password	√	
--Update		
--Set AES Key	√	
--Keypad Lock	√	
--Auto Provision	√	
<b>Other Features</b>		
--Messages		√
--History	√	√
--Directory		√
--Contacts		√
--Blacklist		√

**Note:**

1. The above table only indicates most of phone functions rather than all of them.



Please refer to the relating parts for more details.

The default administrator password is **admin**.

# Customizing Your Phone

## General Settings

### Phone Status

You can view the status of your phone using the Phone interface or the Web interface. This option allows you to review:

- Network status: IP, Mac, Gateway, DNS, WAN, LAN, etc;
- Phone status: Model, Hardware version, Firmware version, Product ID, MAC, etc;
- Accounts: The 3 SIP accounts status;
- Firmware version;

To check the Phone Status via Phone interface:

- 1) Press OK button directly or Menu hot key, choose the Status option.
- 2) Use the navigation keys to scroll through the list and check the specific one.

To view the Phone Status via Web interface:

Open the web browsers and input the IP Address `http://WAN-ip-address`; Enter the account and password (default account and password are both "admin"), choose Status directly to check the status.

### Language

The default Phone interface language is **English**. The Web interface language depends on your computer Operation System. It will automatically match the language with your computer and browser.

It also supports Simplified Chinese, Traditional Chinese, French, German, Italian, Polish, Turkish, Portuguese, Spanish, etc. You can change the language for the phone user interface and the web user interface independently from each other.

**Note:**

All languages may not be available for selection. The available languages depend on the language packs currently loaded to the IP phone. Please contact with your system administrator for more information about loading language packs.

To change the language via Phone interface:

- 1) Press Menu->Settings->Basic Settings->Language.
- 2) Scroll through the list of available languages.
- 3) Press the Save hot key when the desired language is highlighted. The language appears on the graphic display will be changed to the one you chose.



- 4) Press Save hot key to save the changes.
- 5) Press Back hot key to return to the previous screen.

## Time and Date

The time and date appears on the idle screen of the IP phone. If the phone cannot obtain a time and date from the call server, please contact your system administrator if the time or date is incorrect. You can set the time manually or via the SNTP server which is used to synchronize the time.

To change the Time and Date via the Phone interface:

- 1) Press Menu->Settings->Basic Settings->Time & Date.
- 2) If SNTP Settings is chosen, the phone will automatically get the time from the specific NTP Server. Use the navigation keys to highlight the specific option and the relating changes. You can set the Time Zone, NTP Server1/Server2, and Daylight Saving respectively.

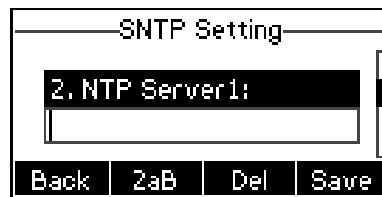

- 3) If Manual Setting is chosen, the time can be set manually. Use the navigation keys to highlight the option and enter the specific date and time.

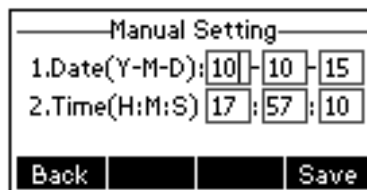

- 4) Press Save hot key, the time appears on the idle screen will be changed. Press Back hot key to return to the previous screen.

To set the time format via the Phone interface:

- 1) Press Menu->Settings->Basic Settings->Time & Date->Time & Date Format.



- 2) Use the Switch hot key to choose a preferred time format: 12 hour or 24 hour.

- 3) Use the Switch hot key to choose a preferred date format, the IP phone can support 7 kind of date display format.
- 4) Press the Save hot key to save the changes and return to the previous screen.

To change the Time and Date via the Web interface:

Choose Phone->Preference to do the relating changes. You can also change the Update Interval which specifies the time frequency that the phone refreshes the time automatically. Please refer to the instruction above for the parameters' detail.

Parameter	Value	Help
WEB Language	English	?
DHCP Time	Disabled	
Time Zone	+8 China(Beijing)	?
Primary NTP Server	cn.pool.ntp.org	?
Secondary NTP Server	cn.pool.ntp.org	?
Update Interval(seconds)	1000	?
Daylight Saving Time	Automatic	?
Fixed Type	<input checked="" type="checkbox"/> By Date <input type="checkbox"/> By Week	
StartTime	Month <input type="text"/> Day <input type="text"/> Hour <input type="text"/>	
EndTime	Month <input type="text"/> Day <input type="text"/> Hour <input type="text"/>	
Offset(minutes)	<input type="text"/>	
Manual Time	Disabled	?
Time Format	24 Hour	?
Date Format	WWW MMM DD	?
Live Dialpad	Disabled	?
Inter Digit Time(1~14)(seconds)	4	?
Flash Hook Time(<800ms)	1	?
Backlight Time(seconds)	30	?
Keyboard Lock	Disabled	?
WatchDog	Enabled	

**NOTE**

**Time Zone**  
Choose the time zone you are in.

**NTP Server**  
The server which is used to synchronize the clock of the phone.

**Update Interval**  
Specify the interval at which the unit will refresh the time.

**Daylight Saving Time**  
The parameter used to active the daylight saving time.

**Manual Time**  
Enable or disable to set time manually.

**Ring Tone**  
The upload ringtones must be format of wav whose sampling rate should be 8K, mono, 16-bit U-law compression

To change the Daylight Saving Time settings via the Phone interface:

- 1) Press Menu->Settings->Basic Settings->Time & Date->SNTP Settings->Daylight Saving.

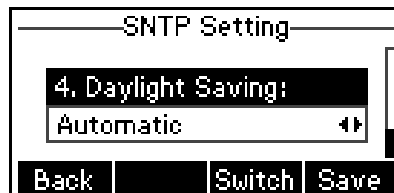

- 2) Press the Switch hot key to choose Off/On/Automatic options.
- 3) Press the Save hot key to save the changes.

To change the Daylight Saving Time Settings via the Web interface:

- 1) Choose Phone->Preference->Daylight Saving Time to do the relating changes.
- 2) Choose Enable option, then you can set the Daylight Saving Time.
- 3) Choose Automatic. There is a table named as AutoDST.xml has been saved in the configuration file, If the table includes daylight saving time of your time zone, it will

show the Fixed Type: By Date or By Week. And the daylight saving time is unchangeable, unless to update the AutoDST.xml via auto provision.

The screenshot shows the Yealink web interface for configuring a phone. The 'Phone' tab is selected, and the 'Fixed Type' is set to 'By Date'. The 'Daylight Saving Time' is set to 'Automatic'. A tooltip 'Daylight Saving Time settings' is visible over the 'By Date' radio button. The interface includes various configuration options such as WEB Language, DHCP Time, Time Zone, NTP Servers, Update Interval, Manual Time, Time Format, Date Format, Live Dialpad, Inter Digit Time, Flash Hook Time, Backlight Time, Keyboard Lock, and WatchDog. A 'NOTE' section on the right provides additional information about Time Zone, NTP Server, Update Interval, Daylight Saving Time, Manual Time, and Ring Tone.

**Note:**

By default the time zone is +8 China(Beijing), Daylight Saving Time is Automatic.

## Keypad Lock

You can lock the keypad of your phone when you are temporarily not using it. This function helps you to protect your phone from unauthorized use. You can lock the following specific keys:



**Menu Key:** The Menu hot keys can not be used until unlocked. You can not access the menu of the phone.

**Function Keys:** The hard function keys (MESSAGE, FORWARD, RD, OK, X, navigation Keys, Volume adjustment button and line keys) can not be used until unlocked. You can not access the hot keys such as Conf, Hold, Mute, Tran, History, Dir, DND, etc either.

**All Keys:** All of the keys can not be used until unlocked. You can only use the phone to answer the incoming calls.

**Lock&Answer:** You can only use the phone to answer the incoming calls (But can not hung up the call by your party) . Or enter the menu pages to do some configurations.

To enable keypad lock via Phone interface:

- 1) Press Menu->Settings->Advanced Settings, enter the password, and then press Confirm hot key.
- 2) Choose Keypad Lock option.
- 3) Use the navigation key to highlight the one you want to lock.
- 4) Press Save hot key to active the change, or Back hot key to return to the previous screen.
- 5) The icon  will be displayed on the top right corner of the idle screen.
- 6) If you choose Lock&Answer, it will show the icon  and  on the user interface.

To unlock the phone via Phone interface:

- 1) Press Menu hot key, you are prompted for the password.
- 2) Enter the password, and then press Confirm hot key, the phone is unlocked.
- 3) The icon will be disappearing from the idle screen.
- 4) If you choose Lock&Answer, you have to enter Menu->Settings->Advanced Settings->Keypad Lock to disable this option.

To enable keypad lock via Web interface:

Choose Phone->Preference-> Keyboard Lock to do the relating changes. Please refer to the instruction above for the parameters' detail.

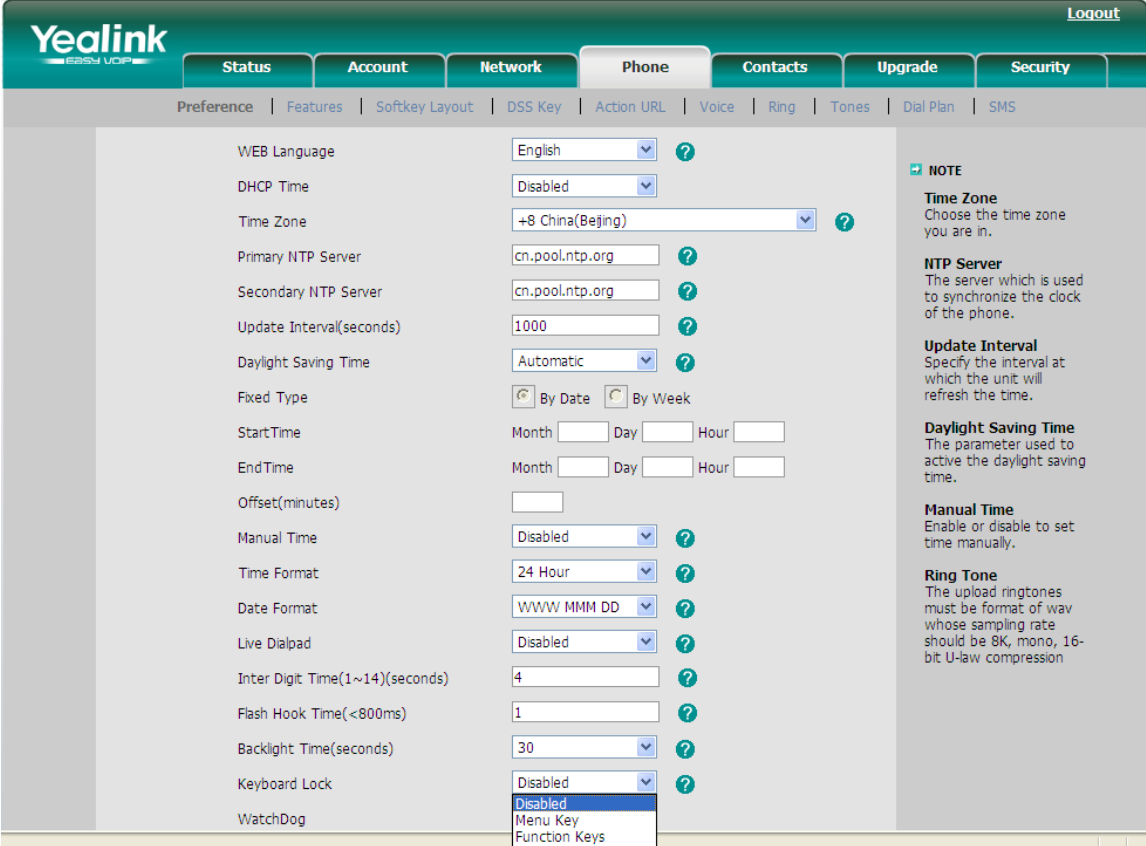

The screenshot shows the Yealink web interface for configuring a phone. The 'Phone' tab is selected, and the 'Preference' sub-tab is active. The 'Keyboard Lock' setting is currently set to 'Disabled'. A dropdown menu is open for this setting, showing options: 'Disabled', 'Menu Key', and 'Function Keys'. To the right, a 'NOTE' section provides additional information:

- Time Zone:** Choose the time zone you are in.
- NTP Server:** The server which is used to synchronize the clock of the phone.
- Update Interval:** Specify the interval at which the unit will refresh the time.
- Daylight Saving Time:** The parameter used to active the daylight saving time.
- Manual Time:** Enable or disable to set time manually.
- Ring Tone:** The upload ringtones must be format of wav whose sampling rate should be 8K, mono, 16-bit U-law compression.

**Note:**

1. The default password for unlock is **admin**.

## Audio Settings

### Volume

You can adjust the volume of handset/speaker/headset/Ring Volume.

To adjust the volume when you are not in an active call:

- 1) Press Menu->Settings->Basic Settings.
- 2) Scroll to Phone Volume, and press Enter hot key, highlight the one you want to adjust the volume, use the Volume Adjustment Bar or navigation keys to adjust the volume.

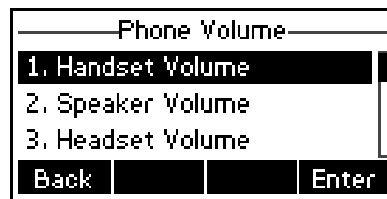

- 3) Press OK hot key to save the change or Back hot key to cancel.
- 4) And you can also press the Volume Adjustment Bar to adjust the ring volume when the phone is in idle status.

To adjust the volume when you are on an active call:

When Handset/Headset/Hands-free mode is activated, press the Volume Adjustment Bar to a comfortable level.

#### Note:

The volume can only be adjusted via Phone interface. When you adjust the ring volume to 0, or press the Silence hot key when there is incoming call, the icon  will be shown on the LCD. Press the Volume Adjustment Bar to adjust the volume, and the icon will disappear.

### Ring Tones

You can adjust the type and volume of the ring tone.

To adjust the Ring Tone Type via Phone interface:

- 1) Press Menu->Settings->Basic Settings.
- 2) Scroll to Ring Tone, and press Enter hot key.
- 3) Use the navigation keys to highlight the specific one.



- 4) Press Save hot key to save the change or Back hot key to cancel.

To change the Ring Tone Type via Web interface:

Choose Phone->Preference->Ring Type, highlight the specific one in the scroll-down menu, click confirm button to update the change. You can also delete the specific one by clicking the Delete button.

The screenshot displays the configuration page for an IP phone. The 'Ring Type' dropdown menu is open, showing a list of ringtone files: Ring1.wav, Ring2.wav, Ring3.wav, Ring4.wav, Ring5.wav, Ring6.wav, Ring7.wav, and Ring8.wav. The 'Ring1.wav' option is currently selected. To the right of the dropdown, there are buttons for 'Del' (Delete) and '浏览...' (Browse). Below the dropdown is a 'Confirm' button. The background shows various other configuration settings such as Time Zone, NTP Server, Update Interval, Daylight Saving Time, Fixed Type, Start/End Time, Offset, Manual Time, Time/Date Format, Live Dialpad, Inter Digit Time, Flash Hook Time, Backlight Time, Keyboard Lock, WatchDog, and Upload Ringtone.

**Note:**

The ring tone file of system cannot be deleted.

To upload the new Ring Tone via Web interface:

- 1) Choose Phone->Preference->Upload Ringtone.
- 2) Click Browse button to choose the specific ring tone file.
- 3) Click Upload button to upload the file.

**Note:**

1. The ring tone file format must be in 16bits WAV format (via Ulaw Compression), 8K sample rate (monophony).
2. Blank or other special characters can not be included in the file name.

To specify ring tones for a specific account via Web interface:

Choose Account->Basic->Ring Type option, and highlight the preferred one for the chosen account in the scroll-down menu, then click confirm button to save the changes.



Display Name	101		
Register Name	101		
User Name	101		
Password	•••		
SIP Server	10.1.4.47	Port	5060
Enable Outbound Proxy Server	Disabled		
Outbound Proxy Server		Port	5060
Transport	UDP		
Backup Outbound Proxy Server		Port	5060
NAT Traversal	Disabled		
STUN Server		Port	3478
Voice Mail			
Proxy Require			
Anonymous Call	Off		
On Code			
Off Code			
Anonymous Call Rejection	Off		
On Code			
Off Code			
Missed call log	Enabled		
Auto Answer	Disabled		
Ring Type	common		

Codecs >> ?  
 Ring1.wav  
 Ring2.wav  
 Ring3.wav  
 Ring4.wav  
 Ring5.wav  
 Ring6.wav  
 Ring7.wav  
 Ring8.wav

Advanced >>

User account, provided by VoIP service provider.

**NAT Traversal**  
Defines the STUN server will be active or not.

**Proxy Require**  
A special parameter just for Nortel server. If you login to Nortel server, the value should be:  
com.nortelnetworks.firewall

**Codecs**  
Choose the codecs you want to use.

**Advanced**  
The Advanced parameters for administrator.

## Codec Selection

The IP phone supports the following voice codecs: G722, G723\_53, G723\_63, G726-16, G726-24, G726-32, G726-40, G729, PCMU and PCMA.

You can enable/disable the desired codecs via Web interface. Please contact your System Administrator for more details about the codecs.

To enable/disable the codecs:

- 1) Choose Account->Codecs.

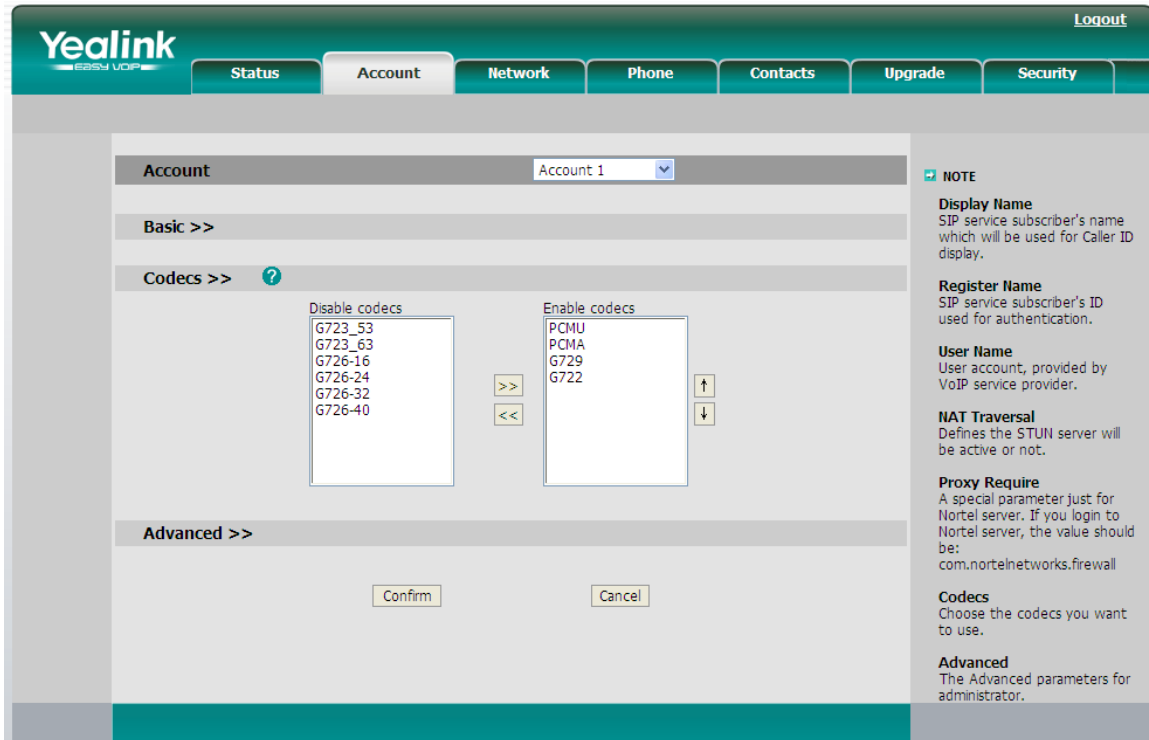

- 2) Use the navigation keys to highlight the desired one in the Enable/Disable Codecs list, and press the >> / << to move to the other list.
- 3) Click Confirm to save the change.

**Note:**

Codec Selection can only be set via Web interface.

## Contact Management

### Edit/Add/Delete Contact

You can store a large number of contacts in your phone's contact list. You can add, edit, delete, dial, and search for a contact in the contact list.

The directory includes Local Directory, Blacklist , Remote Phonebook and Broadsoft.

To add a Group via Phone interface:

- 1) Press Dir->Local Directory
- 2) Press Group hot key to enter to the Add Group page.
- 3) Enter the group name and choose the ring.
- 4) Press the save hot key to save.



To add a contact via Phone interface:

- 1) Press Dir->Local Directory
- 2) Choose a group, and press the Enter hot key.
- 3) Press Add hot key, enter Name, Office, Mobile, Other and Account options of the contact by the keypad. Use the abc hot key to select between numeric and upper/lower case alphanumeric modes.
- 4) Use the navigation keys to select the desired account as Line if you want to assign the contact to a specific account.
- 5) Choose and set a special ring tone for the contact.
- 6) Use the navigation keys to select the group which you want to assign.
- 7) Press Save hot key to add the contact or Back hot key to cancel the change.

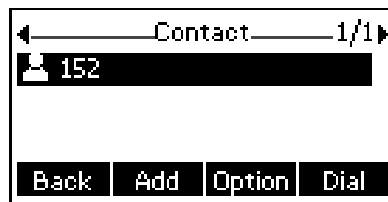

To edit a contact via Phone interface:

- 1) Press Dir->Local Directory
- 2) Choose a group, and press the Enter hot key.
- 3) Use the navigation key to highlight the one you want to edit, press Option->Detail, enter to the edit interface.
- 4) And then make the changes, press Save hot key to save the changes, or press Back hot key to return to the directory.



To delete a contact via Phone interface:

- 1) Press Dir->Local Directory
- 2) Choose a group, and press the Enter hot key.
- 3) Use the navigation key to highlight the one you want to delete, press Option hot key, and scroll to Delete, press OK hot key.
- 4) It will pop up a warning frame asking whether confirm to delete the contact.
- 5) Press OK hot key to confirm the operation, or press the Cancel hot key to return to the directory.



To move a contact to the Blacklist via Phone interface:

- 1) Press Dir->Local Directory
- 2) Choose a group, and press the Enter hot key.
- 3) Use the navigation key to highlight the one you want to move, press Option hot key, and scroll to Move to Blacklist, press OK hot key.
- 4) It will pop up a warning frame asking whether confirm to move the contact.
- 5) Press OK hot key to confirm the operation, or press the Cancel hot key to return to the directory



**Note:**

If the contact is moved to the blacklist, then the call from this contact can not get through.

To move a contact in History to Contacts via Phone interface:

- 1) Press History hot key to enter the call history list.
- 2) Use the navigation keys to highlight a record, and then press the Option hot key to pop up the frame, highlight Add to Contacts option, then press the OK hot key to enter the edit interface.
- 3) Press the abc hot key to switch the input mode.
- 4) After the edition, press the Save hot key to save the change. Then you can go to Contacts interface to check the record.



To search a contact via Phone interface:

- 1) Press Dir->Local Directory->Search.
- 2) It will turn to the search interface, and then you can enter the query condition, press the OK hot key.
- 3) Then the phone will show the record which qualified.



To add/delete/edit/move the contacts via the Web interface:

Choose Contacts->Local Phone Book. Please refer to the instruction above for the parameters' detail.

The screenshot displays the Yealink web interface for managing contacts. The top navigation bar includes 'Status', 'Account', 'Network', 'Phone', 'Contacts', 'Upgrade', and 'Security'. The 'Contacts' section is active, showing a table of contacts under 'Local PhoneBook'.

Index	Name	Office Num	Mobile Num	Other Num	Account	Groups	
1	aa	123456			Auto		<input type="checkbox"/>
2	ss	0599123456			Auto		<input type="checkbox"/>
3	vv	5896			Auto		<input type="checkbox"/>
4							<input type="checkbox"/>
5							<input type="checkbox"/>
6							<input type="checkbox"/>
7							<input type="checkbox"/>
8							<input type="checkbox"/>
9							<input type="checkbox"/>
10							<input type="checkbox"/>

Below the table, there are form fields for adding or editing a contact:

**Contacts**

Name:

Office Num:

Mobile Num:

Other Num:

Account:

Ring:

Groups:

**Group Information**

Groups:

Ring:

**Please select the contacts list file**

**NOTE**

**Add Contact/Blacklist**  
Fill out the contact information. User shouldn't leave contact name blank.

**Delete Contact/Blacklist**  
Select the contact you want to delete in the grid, and then press the button Delete to confirm.

**Move to Contact/Blacklist**  
Choose the contacts you want to move in the grid, and press the button move to Contact/Blacklist to move it.

**Import**  
Browse the file in XML format.

**Export**  
Click Export button and create a file with whose name you prefer to export.

## Import/Export Contact list

Import/Export Contact List via Web interface:

- 1) Choose Contacts-> Local Phone Book.

The screenshot displays the Yealink web interface for managing contacts. At the top, there is a navigation bar with tabs for Status, Account, Network, Phone, Contacts, Upgrade, and Security. Below this, there are links for Local PhoneBook, BlackList, Remote PhoneBook, Phone Call Info, LDAP, Broadsoft, and Call Log. The main content area is titled 'Contacts' and shows a table of contacts with columns for Index, Name, Office Num, Mobile Num, Other Num, Account, and Groups. Below the table, there are sections for adding, editing, and deleting contacts, as well as group information and import/export options. A sidebar on the right contains a 'NOTE' section with instructions for adding, deleting, moving, and exporting contacts.

- 2) Browse the specific contact list file in .XML or .csv format, and then click Import button. The imported contact lists will be showed in the Contact List.
- 3) Move the mouse to the icon , you will see the notes for parameters. The meanings of this icon on other pages is the same, we will not elaborate it one by one.
- 4) Click the Export button to export the contact list.

**Note:**

Import/Export Contact List can be only set via Web interface.

## Blacklist

If you add a contact to blacklist, then the call from this contact cannot get through. The operation of blacklist is the same as contact.

**Yealink** EASY VOP Logout

Status Account Network Phone **Contacts** Upgrade Security

Local PhoneBook | **BlackList** | Remote PhoneBook | Phone Call Info | LDAP | Broadsoft | Call Log

**BlackList** Hangup

Index	Name	Office Num	Mobile Num	Other Num	Account
1	abc	124785	0147852		Auto
2					
3					
4					
5					
6					
7					
8					
9					
10					

Page: 1

Name   
Office Num   
Mobile Num   
Other Num   
Account

**NOTE**  
blacklistnote

## Remote Phone Book

The IP phone has directory itself, but in the enterprise applications where there are a need for a common phone book. For the maintenance and the update of it, the common phone book is usually carried out on the server or IPPBX to maintain up-to-date public phone book, terminal users need to have remote phone book function. When the users browse the remote phone book, the terminal will check and download the latest information released on the server in time, and display on the terminal for the user.

To set the Remote Phone Book via Web interface:

- 1) Choose Contacts->Remote Phone Book.

**Yealink** EASY VOP Logout

Status Account Network Phone **Contacts** Upgrade Security

Local PhoneBook | BlackList | **Remote PhoneBook** | Phone Call Info | LDAP | Broadsoft | Call Log

Index	Phone Book Url	Phone Book Name
1	http://adsca....	abc
2		
3		
4		
5		

**NOTE**  
**Remote phone book**  
This feature allows you to download contact list from the server. Input the phonebook URL and rename the phonebook

- 2) Input the Phone book URL and the phone book name, then click the Confirm button to save the changes.

To check the Remote Phone Book via Phone interface:

- 1) Press the Dir->Remote phonebook.
- 2) Enter to the Remote Group page, choose a special one, and press the Enter hot key, it will go to the corresponding URL address to download the contact information for you.

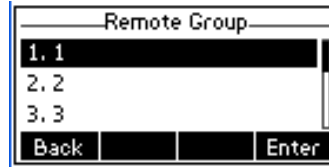

**Note:**

1. This IP phone can support 5 remote phone books at most.
2. Every contact in the remote phone book can set several phone numbers.

## Broadsoft

Broadsoft phone book is the same as the Remote Phone Book. This feature allows you to download contact list from the server. Input the phonebook URL, port, username, password and rename the phonebook

**Yealink** EASY VOIP Logout

Status Account Network Phone **Contacts** Upgrade Security

Local PhoneBook | BlackList | Remote PhoneBook | Phone Call Info | LDAP | Broadsoft | Call Log

Broadsoft Item: Item1 ?  
 Displayname: 111 ?  
 Server: 111 ?  
 Port: 111 ?  
 User: 111 ?  
 Password: ●●● ?

Confirm Cancel

**NOTE**  
**Broadsoft Directory**  
 This feature allows you to download contact list from the server. Input the phonebook URL,port,username,password and rename the phonebook

## LDAP

LDAP can support these functions:

1. Search the contact: Press the DSSkey which is set up as LDAP, input a number or letter in the new interface, the phone will search the contact in LDAP server which following the Certain rules, and show it in the LCD, user can choose the contact to call out.



2. Search the incoming call: the phone will search the local directory when there is a coming call. If they can't find the contact in the local directory, it will search them through LDAP server, and show the contact name in the LCD. The LDAP Lookup For Incoming Call option can be configured to enable or disable this function via web interface.

3. The function of Dial-up directory: under the dial interface, each time you press a key there are inquiring for a number. It will show on the LCD and let the user to choose. The LDAP Lookup For PreDial/Dial option can be configured to enable or disable this function via web interface.

To set the LDAP via the Web interface:

- 1) Choose Contacts->LDAP.
- 2) Configure the corresponding options
- 3) Click Confirm to save the change.

The screenshot displays the Yealink web interface for LDAP configuration. The top navigation bar includes 'Logout' and tabs for 'Status', 'Account', 'Network', 'Phone', 'Contacts', 'Upgrade', and 'Security'. The 'Contacts' tab is active, and the 'LDAP' sub-tab is selected. The main content area shows various LDAP settings with input fields and dropdown menus, each accompanied by a help icon (?). The settings include:

- LDAP Name Filter: [ ]
- LDAP Number Filter: [ ]
- Server Address: 0.0.0.0
- Port: 389
- Base: [ ]
- UserName: [ ]
- Password: [ ]
- Max. Hits(1~32000): 50
- LDAP Name Attributes: [ ]
- LDAP Number Attributes: [ ]
- LDAP Display Name: [ ]
- Protocol: Version3
- Search Delay(ms)(0~2000): 0
- LDAP Lookup For Incoming Call: Enabled
- LDAP Sorting Results: Enabled
- LDAP Lookup For PreDial/Dial: Disabled

At the bottom, there are 'Confirm' and 'Cancel' buttons. A 'NOTE' section on the right indicates 'LDAP settings'.

## Other Settings

### Key as Send

Users can set a specific button ("#" or "\*"") to active as the send button.

To set the send key via the IP phone interface:

- 1) Press Menu->Features->Key as Send->Enter to enter the configuration page.

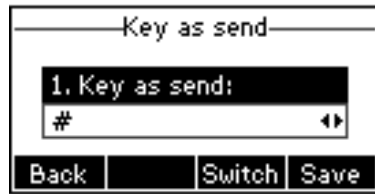

- 2) Press the Switch hot key to choose a button that you want to use as the send key: "#", "\*", or disable this option.
- 3) Press the Save hot key to save the changes.

To set the send key via the Web interface:

- 1) Choose Phone-> Features-> Key As Send.
- 2) Highlight the specific one in the pull-down menu, then click the Confirm button to save the change.

## Hot Line

To set the hot line number via the IP phone interface:

- 1) Press Menu->Features->Hot Line->Enter to enter the configuration page.

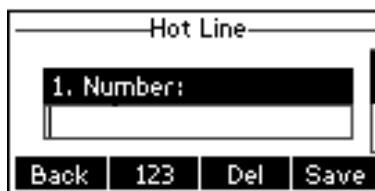

- 2) Enter the hot line number and HotLine Delay time (for example, 20 seconds), then press the Save hot key to save the changes.

- When you pick up the handset or press the speaker button, and it will dial out the number automatically if you do not press any keys for 20 seconds.

To set the Hot Line via the Web interface:

- Choose Phone-> Features.
- Input the Hotline Number and Hotline Delay, then click the Confirm button to save the change.

The screenshot displays a web interface for configuring an IP phone. It includes sections for 'Busy', 'No Answer', and 'General Information'. The 'Hotline Number' field is currently empty, and a tooltip 'Set hotline number' is visible next to it. Other fields include 'Hotline Delay' (set to 4), 'After Ring Time' (set to 10), and 'Busy Tone Delay' (set to 0). The interface uses a combination of text boxes, dropdown menus, and radio buttons for configuration.

## Anonymous call

To set the anonymous call via the IP phone interface:

- Press Menu ->Features-> Anonymous Call ->Enter to enter the configuration page.

The screenshot shows the 'Anonymous Call' configuration screen. It features a single input field labeled '1. Line ID:' containing the text 'Line 1'. Below the field are three buttons: 'Back', 'Switch', and 'Save'. The interface is simple and uses a monochrome color scheme.

- By the Switch hot key, you can choose the Line ID.
- Press the navigation keys to enter and choose whether to enable the anonymous call function. This feature allows the subscriber to make a call with the display of their calling identification information blocked.

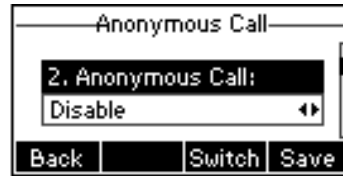

- 4) If you want to realize the anonymous call by server, please choose and enter the Call On Code and Call Off Code. When you choose to enable the anonymous call function on your IP phone, it will send information to the server, and the server will enable/ disable the anonymous call function for your IP phone automatically.

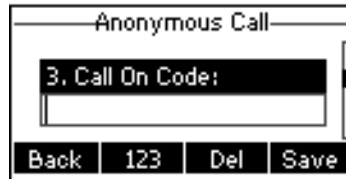

- 5) Press the navigation keys to enter and choose whether to enable the anonymous rejection function. The feature allows the subscriber to reject all calls from callers who have blocked the display of their calling identification information (calling number and calling name).

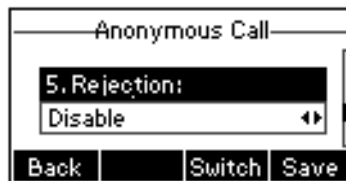

- 6) If you want to realize the anonymous rejection by server, please choose and enter the Reject On Code and Reject Off Code. When you choose to enable the anonymous reject function on your IP phone, it will send information to the server, and the server will enable/ disable the anonymous reject function for your IP phone automatically.

**Note:**

This configuration is only available for the current default account.

- 7) Press the Save hot key to save the changes.

To set the anonymous call via the Web interface:

- 1) Choose Account-> Basic-> Anonymous Call to do the relating changes. Please refer to the instruction above for the parameters' detail.
- 2) Then click the Confirm button to save the changes.

## Auto Redial

Auto redial is a telephone feature that redials a busy number in a fixed number of times before giving up.

To set auto redial via the IP phone interface:

- 1) Press Menu->Features->Auto Redial ->Enter to enter the configuration page.



- 2) By the Switch hot key, you can choose whether to enable the auto redial function.
- 3) Press the navigation keys to choose and set the redial interval, which is used to the set period to redial again when the call is denied access or expire. It is measured by seconds.
- 4) Press the navigation keys to choose and set the redial times.
- 5) Press the Save hot key to save the changes.

To set auto redial via the Web interface:

- 1) Choose Phone->Features->Auto Redial.
- 2) Choose Enabled or Disabled in the pull-down menu, click confirm button to save the change.

## Auto Answer

Auto-answer allows an incoming call to be answered without requiring any action by the user. This is a useful feature for people who have difficulty in using their hands or fingers, who have a visual impairment, or who have a cognitive impairment. You can set this function to a special account.

To set Auto Answer via the IP phone interface:

- 1) Press Menu->Settings->Advanced Settings, enter the password and press enter

- hot key.
- 2) Then choose Accounts->Line X to enter the configuration page, use the navigation keys to choose Auto Answer option.
  - 3) Press the Switch hot key to enable or disable the auto answer function. The default is Disable.
  - 4) Press the Save hot key to save the changes.

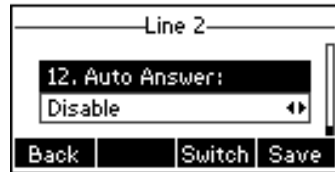

To set Auto Answer via Web interface:

- 1) Choose Account->Basic->Auto Answer.
- 2) Choose Enabled or Disabled in the pull-down menu, click confirm button to save the change.

## Missed call log

Defines whether to save the missed calls to the call history record or display the missed calls on the idle screen. This function can only be set via the Web interface:

- 1) Choose Account->Basic->Missed call log.
- 2) Choose Enabled or Disabled in the pull-down menu, click confirm button to save the change.

## Broadsoft Call Log

This feature allows you to download call history from the server. Input the URL, port, username, password and rename the phonebook

Configure Call Log via web interface:

- 1) Choose Contacts->Call Log
- 2) Choose the Calllog Item.
- 3) Input the display name, URL, port, username and password.
- 4) Click the confirm button to save the changes.

Check Call Log via phone interface:

- 1) Press Menu->History Type->Network Call Log
- 2) Choose the Call log Item, press Enter softkey to download the call log.

## Logo Customization

You can upload your own logo which displayed on the idle screen.

- 1) Choose Phone-> Features-> Use Logo->Custom Logo via the Web interface, press Browse button, and choose the corresponding file.

- 2) Press Upload button to complete the Logo Customization. You will find the desired logo display on the idle screen.

**Note:**

1. You can also upload the Logo by AUTO PROVISION.
2. By the Web interface, users can set a logo to be a System Logo or a Custom Logo, and the Custom Logo can be deleted.
3. Only support DOB format file, For more information please contact the administrator.

## Programmable Key

The hot-key, navigation keys and function keys on the keypad are editable. Users can customize specific features for these keys according to their actual needs.

This function can only be set via the Web interface:

- 1) Choose Phone->DSS Key->Programmable Key.

Key	Type	Line	Extension
SoftKey1	History	Auto	
SoftKey2	N/A	Auto	
SoftKey3	Directory	Auto	
SoftKey4	History	Auto	
Up	DND	Auto	
Down	Menu	Auto	
Left	SwitchAccount	Auto	
Right	SMS	Auto	
OK	NewSMS	Auto	
Cancel	Forward	Auto	
FWD	Redial	Auto	
	Call Return	Auto	
	Pick Up	Auto	
	XML Group	Auto	
	XML PhoneBook	Auto	
	Status	Auto	
	Speed Dial	Auto	
	Local Group	Auto	
	Local PhoneBook	Auto	
	Broadsoft Group	Auto	
	Broadsoft PhoneBook	Auto	

- 2) Choose and customize specific features for these keys.
- 3) Click Confirm button to save the change.





## Softkey Layout

The phone can support 12 kinds of call interface to set up softkey, user can setup different function key according to his/her own requirement or habit.

To set up softkey via web interface:

- 1) Choose Phone->Softkey Layout.

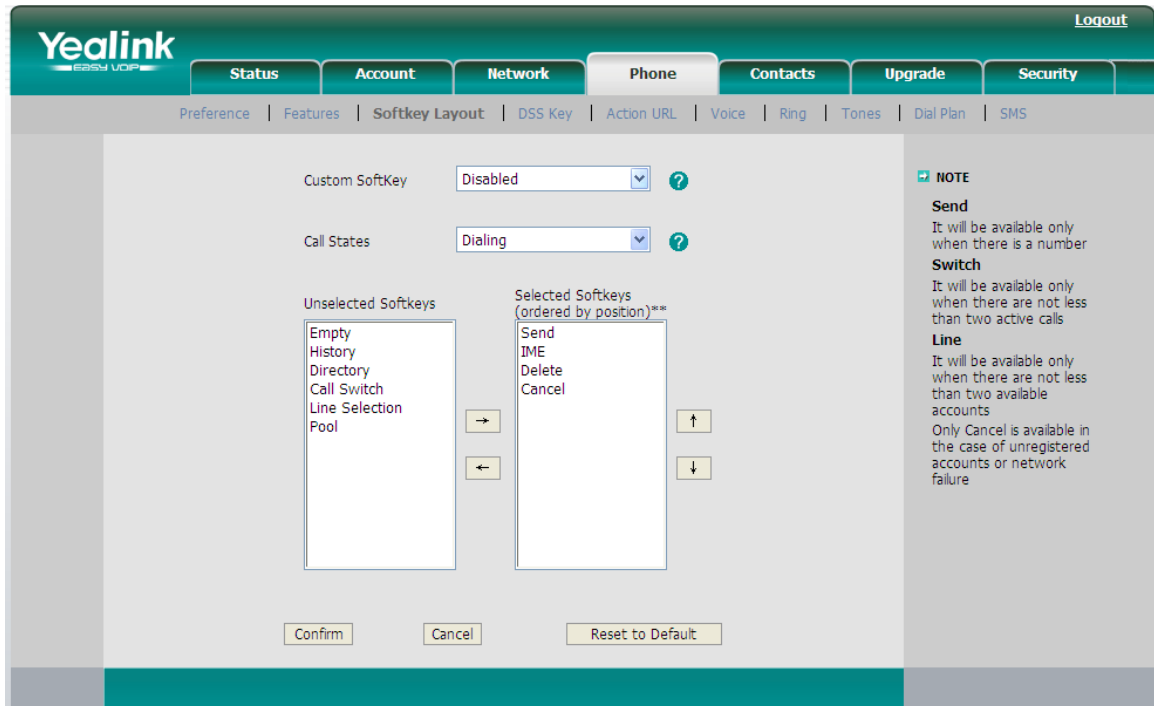

- 2) In the "Custom Softkey" field, chose Enable in the pull-down menu.
- 3) You can choose the corresponding call states which you want to set up the softkey in the Call States field.
- 4) Highlight the desired one in the Unselect Softkeys/Select Softkeys list, and press the  /  to move to the other list.
- 5) And you can use  /  to choose the order how to display in the call states.
- 6) Click confirm to save the changes.
- 7) You can also click the Reset to Default button to reset the softkeys interface.

**Note:**

1. We can add the Empty key more than once, but others can only choose once time, and can't be repeat. when you set up the Selected Softkeys key more than 4 options, the LCD of phone will transfer the forth key with "More" automatically, which can be use to switch to the next page, and continue to show up the other key.

## Live Dialpad

Defines whether to dial out the dialed number automatically.

This function can only be set via the Web interface:

- 1) Choose Phone->Preference->Live Dialpad.
- 2) Enable or disable it in the pull-down menu.
- 3) Click Confirm button to save the change.

## Replace Rule

A dial plan establishes the expected number and pattern of digits for a telephone number. This includes country codes, access codes, area codes and all combinations of digits dialed. For example if you set the *Prefix* as 0 and *Replace* as 0086 (Chinese country code), when you dial 05702000 out, the number will be replaced by 00865702000 automatically.

To set a Dial Plan via the Web interface:

- 1) Choose Phone->Dial Plan->Replace Rule.

The screenshot shows the 'Replace Rule' configuration page in the Yealink web interface. The page has a navigation bar with 'Phone' selected, and a sub-menu with 'Dial Plan' selected. The main content area shows a table of Replace Rules with columns for Index, Prefix, Replace, and Account. Below the table are input fields for Prefix, Replace, and Account, and buttons for Add, Edit, and Del. A 'NOTE' section on the right explains symbols like \* for Digit 0-9, [digit-digit] for any digit, [digit-digit,digit] for a range, x for a single digit, and . for an arbitrary number of digits.

Index	Prefix	Replace	Account
1	0	12456789	1
2	1	05991234	
3			
4			
5			
6			
7			
8			
9			
10			

Prefix:  Replace:  Account:

Add Edit Del

**NOTE**

**Digit 0-9 \***  
Identifies a specific digit (do not use # if it is defined as send key).

**[digit-digit]**  
Identifies any digit dialed that is included in the range.

**[digit-digit,digit]**  
Specifies a range as a comma separated list.

**x**  
Matches any single digit/character which is dialed.

**.**  
Matches an arbitrary number of digits.

- 2) Enter the desired *Prefix*, *Replace* and *Account*.
- 3) Press Add button to save the changes.
- 4) You can also delete a specific one from the dial plan list.
- 5) You can select a record to modify, then click Edit button to submit.

## Dial Now

Dial-now enables you to define the specific length of any number/letter in advance(for example xxx), next time when users dial out the 123 whose length matches the Dial-now rule, the phone will dial out 123 immediately without pressing Send button.

To set a Dial Plan via the Web interface:

- 1) Choose Phone->Dial Plan->Dial Now.

**Replace Rule >>** ?

**Dial-now>>** ?

Index	Dial-now Rule	Account
1	0599	1
2		
3		
4		
5		
6		
7		
8		
9		
10		

Dial-now Rule  Account

**Area Code>>**

**Block Out>>** ?

**NOTE**

**Digit 0-9 \***  
Identifies a specific digit (do not use # if it is defined as send key).

**[digit-digit]**  
Identifies any digit dialed that is included in the range.

**[digit-digit,digit]**  
Specifies a range as a comma separated list.

**x**  
Matches any single digit/character which is dialed.

**.**  
Matches an arbitrary number of digits.

- 2) Enter the number in Dial-now Rule and Account.
- 3) Press Add button to save the changes.
- 4) You can select a record to modify, then click Edit button to submit.
- 5) You can also delete a specific one from the dial plan list by pressing Del button.

**Note:**

1. If need to replace the unknown contents, then you can use (.) or (x), "." stand for a string of char, "x" stand for any one char. The content in ( ) stand for a variable, the first variable is expressed by \$ 1, the second variable is expressed by \$ 2, the rest can be done in the same manner. For example: if you want to replace the any inputdits content with the content beginning with 8. Input (.) in Prefix box, and input 8\$1 in Replace box.

## Area Code

Area codes are also known as Numbering Plan Areas (NPAs). These are necessary (for the most part) only when dialed from outside the code area and from mobile phones. Area codes usually indicate geographical areas within one country, although the correlation to geographical area is becoming obsolete. For non-geographical numbers, as well as mobile telephones outside of the United States and Canada, the "area code" does not correlate to a particular geographic area.

To add the area code via the Web interface:

- 1) Choose Phone->Dial Plan->Area Code.

**Yealink** EASY VOIP Logout

Status | Account | Network | **Phone** | Contacts | Upgrade | Security

Preference | Features | Softkey Layout | DSS Key | Action URL | Voice | Ring | Tones | Dial Plan | SMS

**Replace Rule >>** ?

**Dial-now>>** ?

**Area Code>>**

Code

Min Length(1-15)

Max Length(1-15)

Account

**Block Out>>** ?

**NOTE**

**Digit 0-9 \***  
Identifies a specific digit (do not use # if it is defined as send key).

**[digit-digit]**  
Identifies any digit dialed that is included in the range.

**[digit-digit,digit]**  
Specifies a range as a comma separated list.

**x**  
Matches any single digit/character which is dialed.

**.**  
Matches an arbitrary number of digits.

- 2) Enter the Code and Account, set the Min Length and the Max Length option, and then click the Confirm button to save.

## Block Out

The specific phone numbers can be forbidden to be call out from your IP phone.

- 1) Choose Phone->Dial Plan->Block Out.
- 2) Enter the phone number and Account, and then click Add button to save the changes, or choose the specific one in the list, click Delete button to delete the record.
- 3) You can select a record to modify, then click Edit button to submit.
- 4) You can not dial out the number from your IP phone unless it is removed from the Forbidden List.

**Yealink**  
EASY VOP

Logout

Status Account Network **Phone** Contacts Upgrade Security

Preference | Features | Softkey Layout | DSS Key | Action URL | Voice | Ring | Tones | Dial Plan | SMS

Replace Rule >> ?  
Dial-now>> ?  
Area Code>>  
Block Out>> ?

Index	Block Out Number	Account
1	059914785	
2	12345	
3		
4		
5		
6		
7		
8		
9		
10		

Block Out Number  Account

Add Edit Del

**NOTE**

**Digit 0-9 \***  
Identifies a specific digit (do not use # if it is defined as send key).

**[digit-digit]**  
Identifies any digit dialed that is included in the range.

**[digit-digit,digit]**  
Specifies a range as a comma separated list.

**x**  
Matches any single digit/character which is dialed.

**.**  
Matches an arbitrary number of digits.

**Note:**

1. In the Account field, you can enter 1,2,3..., "1" represents Account 1, "2" represents Account 2 ..... , if the account box is empty, it mean this rule works for all accounts .

## Feature Synchronisation

When enabled the synchronize function, configure the DND/FWD function on device or server, DND/FWD status on device and server will be in correspondence.

To set Feature Key Synchronisation via the Web interface:

- 1) Choose Phone->Features-> Feature Key Synchronisation
- 2) There is a pull-down menu in the Type field, choose Intercom from the list.
- 3) Choose whether to enable this function from the pull-down menu.
- 4) Click the Confirm to save the change.

Hotline Number	<input type="text"/>	?	<p>phone, it will dial out the hotline number automatically.</p> <p><b>Upload Logo</b> The picture must be format of dob, it can be black and white, or 2 gray scale.</p>
Hotline Delay	<input type="text" value="4"/>		
ReDialTone	<input type="text"/>	?	
Emergency	<input type="text"/>	?	
BusyToneDelay(seconds)	<input type="text" value="0"/>	?	
Ringer Device for Headset	<input type="text" value="Use Speaker"/>	?	
Return code when refuse	<input type="text" value="486 (Busy here)"/>	?	
Return code when DND	<input type="text" value="480 (Temporarily not available)"/>	?	
DND On Code	<input type="text"/>	?	
DND Off Code	<input type="text"/>	?	
Enable Semi-Attend Transfer	<input type="text" value="Enabled"/>	?	
Allow Intercom	<input type="text" value="Enabled"/>	?	
Intercom Mute	<input type="text" value="Disabled"/>	?	
Intercom Tone	<input type="text" value="Enabled"/>	?	
Intercom Barge	<input type="text" value="Enabled"/>	?	
Call Completion	<input type="text" value="Disabled"/>	?	
Attend Trans OnHook	<input type="text" value="Enabled"/>		
Feature Key Synchronisation	<input type="text" value="Disabled"/>		
Use Logo	<input type="text" value="Disabled"/> <input type="text" value="Enabled"/>	?	

## Push XML

Users configure the server's IP address on Web page, when phone receives request, it will determine whether to display corresponding content on the phone which sent by the specified server or not.

To set Push XML via Web interface:

- 1) Choose phone->features-> PushXML Server IP, enter the server IP in the field.
- 2) Click the confirm button to save the change.

Intercom Mute	Disabled	?
Intercom Tone	Enabled	?
Intercom Barge	Enabled	?
Call Completion	Disabled	?
Enable Semi-Attend Transfer	Enabled	?
Blind Transfer OnHook	Enabled	
Attend Trans OnHook	Enabled	
Transfer on Conference Hang up	Disabled	
Feature Key Synchronisation	Disabled	
Time Out for Dial-now Rule	1	
ACD Auto Available	Disabled	
ACD Auto Available Timer(0~120s)	60	
RFC 2543 Hold	Disabled	
Use Outbound Proxy In Dialog	Enabled	
IsDeal180	Enabled	
Logon Wizard	Disabled	
PswPrefix		
PswLength	0	
PswDial	Disabled	
PushXML Server IP		
Use Logo	System Logo	?

## WatchDog

When 'WatchDog' function is 'Enabled', phone will auto reboot after 10 seconds if some important process of phone crash. When 'Disable' the function, the phone will not reboot.

Configure watchdog via web interface:

Choose phone-> Preference->WatchDog, in the pull-down menu, choose enable or disable this function.

Secondary NTP Server	<input type="text" value="cn.pool.ntp.org"/>	?	<p><b>NTP Server</b> The server which is used to synchronize the clock of the phone.</p> <p><b>Update Interval</b> Specify the interval at which the unit will refresh the time.</p> <p><b>Daylight Saving Time</b> The parameter used to activate the daylight saving time.</p> <p><b>Manual Time</b> Enable or disable to set time manually.</p> <p><b>Ring Tone</b> The upload ringtones must be format of wav whose sampling rate should be 8K, mono, 16-bit U-law compression</p>
Update Interval(seconds)	<input type="text" value="1000"/>	?	
Daylight Saving Time	<input type="text" value="Automatic"/>	?	
Fixed Type	<input checked="" type="radio"/> By Date <input type="radio"/> By Week		
StartTime	Month <input type="text"/> Day <input type="text"/> Hour <input type="text"/>		
EndTime	Month <input type="text"/> Day <input type="text"/> Hour <input type="text"/>		
Offset(minutes)	<input type="text"/>		
Manual Time	<input type="text" value="Disabled"/>	?	
Time Format	<input type="text" value="24 Hour"/>	?	
Date Format	<input type="text" value="WWW MMM DD"/>	?	
Live Dialpad	<input type="text" value="Disabled"/>	?	
Inter Digit Time(1~14)(seconds)	<input type="text" value="4"/>	?	
Flash Hook Time(<800ms)	<input type="text" value="1"/>	?	
Backlight Brightness	<input type="text" value="2"/>	?	
Backlight Time(seconds)	<input type="text" value="30"/>	?	
LCD Contrast	<input type="text" value="6"/>	?	
Keyboard Lock	<input type="text" value="Disabled"/>	?	
WatchDog	<input type="text" value="Enabled"/>		
Ring Type	<input type="text" value="Ring1.wav"/> <input type="button" value="Del"/>	?	
Upload Ringtone	<input type="text"/> <input type="button" value="浏览..."/>		
	<input type="button" value="Upload"/> <input type="button" value="Cancel"/>		
	<input type="button" value="Confirm"/> <input type="button" value="Cancel"/>		

## Action URL/URI

Action URL: Record the operation of phone, send these corresponding information to server; Action URI: Remote control phone for corresponding operation.

The operation can be recorded include: Setup Completed, Log On, Log Off, Register Failed, Off hook, On hook...etc.

Set Action URL via web interface:

- 1) Choose Phone->Action URL
- 2) Enter the Corresponding contents
- 3) Click Confirm to save the changes.



### Action URI:

Enter the "http://Phone ip/cgi-bin/ConfigManApp.com?key=xxx" in Browser address bar, the phone will realizing the corresponding function. If you not login the web with the user name and password, you will need to specify the user/password to confirm the operation. The username/password can be added into the URI like:

http://admin:admin@10.2.3.25/cgi-bin/ConfigManApp.com?key=OK

Our phone can support the following functions function:

Phone ip stand for the phone's IP address. Key=xxx stand for the following rules:

To answer the call: key=OK/key=ENTER

To turn on speaker mode: key=SPEAKER

Press transfer button: key=F\_TRANSFER

Increasing the volume: key=VOLUME\_UP

Reduce the volume: key=VOLUME\_DOWN

To mute the call: key=MUTE

To hold the call: key=F\_HOLD

To end the call: key=X

To enter the DTMF number(include Numeric , \* or # keys): key=0-9\*/POUND

Press a line key: key=L1-L6

Press Conference button: key=F\_CONFERENCE

Press a soft key: key=F1-F4

Press Message button: key=MSG

Press Headset button: key=HEADSET

Press RD button: key=RD

Press navigation key: key=UP/ DOWN/ LEFT/ RIGHT

To reboot the phone: key=Reboot

To check the Auto provision: key=AutoP

To enable DND: key=DNDOn

To disable DND: key=DNDOff

Dial out:

[http://phone IP/cgi-bin/ConfigManApp.com?number=NUMBER&outgoing\\_uri=URI](http://<u>phone IP</u>/cgi-bin/ConfigManApp.com?number=<u>NUMBER</u>&outgoing_uri=<u>URI</u>)

Phone ip stand for the phone's IP address. NUMBER stand for the number which you want to send. URI stand for the account.

For example:

[http://10.2.3.25/cgi-bin/ConfigManApp.com?number=0599123456&outgoing\\_uri=216@192.168.1.199](http://<u>10.2.3.25</u>/cgi-bin/ConfigManApp.com?number=<u>0599123456</u>&outgoing_uri=<u>216@192.168.1.199</u>)

NOTE:



If there is no account, or the account abnormal, the phone will dial out with the default account.

# Using the Basic Call Functions

## Making a call

### Call Devices

You can make a phone call via the following devices:

- 1) Pick up the handset,  icon will be showed in the idle screen.
- 2) Press the Speaker button,  icon will be showed in the idle screen.
- 3) Press the Headset button if the headset is connected to the Headset Port in advance.  
The icon  will be showed in the idle screen.

You can also dial the number first, and then choose the method you will use to speak to the other party.

### Call Methods

You can dial the number directly if you didn't register a account but fill the SIP Server in the registered interface. But the number which you dial must be in the same SIP server.

You can press an available line button if there is more than one account, then

- 1) Dial the number you want to call, or
- 2) In dial-up interface, press Pool hot key, use the navigation button to highlight your choice, enter into the corresponding option or
- 3) Press the RD button to enter the Dialed Calls interface, choose a record to call out, or
- 4) Press the DSS keys which have been set as speed dial button.

Then press the Send button or Send hot key to make the call out if necessary.

And you can also dial-up via web interface:

- 1) Choose Contact->Local Phone Book/BlackList, click the number which you want to dial out, and then the phone will dial out by default account.

**Yealink**  
EASY VOP

Status Account Network Phone **Contacts** Upgrade Security

Local PhoneBook | BlackList | Remote PhoneBook | Phone Call Info | LDAP | Broadsoft | Call Log

Contacts All Contacts ? Hanqun

Index	Name	Office Num	Mobile Num	Other Num	Account	Groups
1	aa	123456			Auto	
2	ss	0599123456			Auto	
3	vv	5896			Auto	
4						
5						
6						
7						
8						
9						
10						

Page: 1 Prev Next Move To BlackList Delete All Del

**Contacts**

Name:   
 Office Num:   
 Mobile Num:   
 Other Num:   
 Account: Auto  
 Ring: Auto  
 Groups: N/A

Add Edit Search

**Group Information**

Groups:   
 Ring: Auto

Add Edit Del Delete All

**Please select the contacts list file**

浏览...  
 Import XML Export XML

浏览...  
 Import CSV Export CSV

Show title

**NOTE**

**Add Contact/Blacklist**  
 Fill out the contact information. User shouldn't leave contact name blank.

**Delete Contact/Blacklist**  
 Select the contact you want to delete in the grid, and then press the button Delete to confirm.

**Move to Contact/Blacklist**  
 Choose the contacts you want to move in the grid, and press the button move to Contact/Blacklist to move it.

**Import**  
 Browse the file in XML format.

**Export**  
 Click Export button and create a file with whose name you prefer to export.

- 2) Or choose Contact->Phone Call Info, enter the number in the Dial a Number, select the line from the Outgoing Identity list. Then click the dial button to call out.
- 3) Or choose Contact->Phone Call Info, click the number which you want to dial out from the call list, the phone will dial out by corresponding account.

The screenshot shows the Yealink web interface for managing contacts. At the top, there's a navigation bar with tabs for Status, Account, Network, Phone, Contacts, Upgrade, and Security. Below this, there's a sub-navigation bar with links for Local PhoneBook, BlackList, Remote PhoneBook, Phone Call Info, LDAP, Broadsoft, and Call Log. The main content area is titled 'Contacts' and features a table with columns: Index, Name, Office Num, Mobile Num, Other Num, Account, and Groups. The table lists two contacts: 'qq' with Office Num '123' and 'ww' with Office Num '0599'. Below the table are navigation buttons: Page: 1, Prev, Next, Move To BlackList, Delete All, and Del. To the right of the table is a 'Hangup' button. Below the table are two form sections: 'Contacts' and 'Group Information'. The 'Contacts' form has fields for Name, Office Num, Mobile Num, Other Num, Account (dropdown), Ring (dropdown), and Groups (dropdown), with Add, Edit, and Search buttons. The 'Group Information' form has fields for Groups and Ring (dropdown), with Add, Edit, Del, and Delete All buttons. Below these forms is a section titled 'Please select the contacts list file' with two file upload fields and buttons for Import XML, Export XML, Import CSV, and Export CSV. On the far right, there's a 'NOTE' section with instructions for adding, deleting, and moving contacts, and an 'Import' and 'Export' section with instructions for file handling.

4) You can click the Hangup button to end the call in the web page.

## Password dial

When number entered is beginning with the password prefix, the following N numbers after the password prefix will be hidden as \*, N stand for the value which you enter in the PswLength field. For example: you set the password prefix is 3, enter the PswLength is 2, then you enter the number 34567, it will display 3\*\*67 on the phone. Set password dial via web interface:

- 1) Choose phone->features->PswDial, in the pull-down menu, choose enable.
- 2) Enter the password prefix in the PswPrefix field
- 3) Enter the Length in the PswLength field.
- 4) Click the confirm to save the changes.

Intercom Mute	Disabled	?
Intercom Tone	Enabled	?
Intercom Barge	Enabled	?
Call Completion	Disabled	?
Enable Semi-Attend Transfer	Enabled	?
Blind Transfer OnHook	Enabled	
Attend Trans OnHook	Enabled	
Transfer on Conference Hang up	Disabled	
Feature Key Synchronisation	Disabled	
Time Out for Dial-now Rule	1	
ACD Auto Available	Disabled	
ACD Auto Available Timer(0~120s)	60	
RFC 2543 Hold	Disabled	
Use Outbound Proxy In Dialog	Enabled	
IsDeal180	Enabled	
Logon Wizard	Disabled	
PswPrefix		
PswLength	0	
PswDial	Disabled	
PushXML Server IP		
Use Logo	System Logo	?

## Call Completion

Have encountered such a situation? When you call a contact, but the other side is busy on a call. Do you want the server to inform you immediately when the contact end the call, in order to establish a conversation with each other in time? Call Completion can help you to solve this problem.

To configure Call Completion via phone interface:

- 1) Press the following hot keys: Menu->Features ->Call Completion to enter the configuration page.



- 2) By the Switch soft key, choose whether to enable this option.
- 3) Press the Save soft key to save your changes.

## Answering a call

### Answering an incoming call

- 1) If you are not on another phone, lift the handset using, or press the Speaker button/ Answer hot key to answer using the speakerphone, or press the headset button to answer using the headset.
- 2) If you are on another call, press Answer hot key to answer the call, or press the Reject hot key to refuse it.
- 3) You can also press the Silence hot key to mute the call.

During the conversation, you can alternate between Headset, Handset and Speaker phone by pressing the corresponding buttons or picking up the handset.

### Denying an incoming call

Press Reject hot key to deny the incoming call directly.

## DND

Press DND hot key to active DND Mode when the phone is in idle status. Further incoming calls will be rejected and the display shows:  icon. Press it again to deactivate DND mode. You can find the incoming call record in the Call History.

You can also set DND function by the DND Code:

- 1) Go to Menu->Features->DND Code to enter the configuration interface.

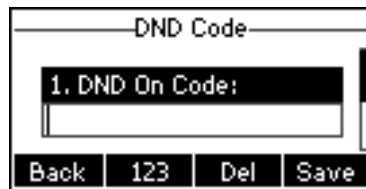

- 2) Set the DND On Code and the DND Off Code, then press the Save hot key to save the changes.
- 3) When you press the DND hot key, the phone will send a message to the server, and the server will turn on the DND function. Then any calls to the extension will be rejected by the server automatically. And the incoming call record will not be displayed in the Call History.

## Call Forward

This feature allows you to forward an incoming call to another phone number e.g. a cell phone or voice mailbox.

The following call forwarding events can be configured:

- *Always:* Incoming calls are immediately forwarded.
- *Busy:* Incoming calls are immediately forwarded when the phone is busy.
- *No Answer:* Incoming calls are forwarded when the phone is not answered after a specific period.

To configure Call Forward via Phone interface:

- 1) Press the following hot keys: Menu->Features->Call Forward->Enter.

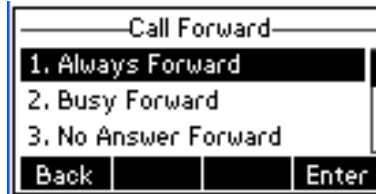

- 2) There are 3 options: Always Forward, Busy Forward and No Answer Forward.
- 3) Choose one of them, enter the phone number you want to forward.



- 4) If you want to realize this function by the server, please enter the On Code and Off Code option, then when you choose to enable the call forward function via your IP phone, it will send message to the server, and the server will turn on the function immediately. When there are calls to the extension, the server will forward it to the set number automatically based on the forward type. And the IP phone will not show the record in the call history anymore.



- 5) Press Save to save the changes.

To configure Call Forward via Web interface:

Choose Phone->Features->Call Forward to do the relating changes. Please refer the above configuration information.

## Intercom

Intercom mode is useful in an office environment as a quick access to connect to the operator or the secretary.

To configure Intercom option via phone interface:

- 1) Press the following hot keys: Menu->Features->Enter->Intercom->OK to enter the configuration page.



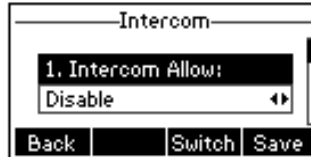

- 2) Intercom Allow: To set whether to answer the incoming intercom calls.
- 3) Intercom Mute: To set whether to mute the incoming intercom calls automatically.
- 4) Intercom Tone: To set whether to play ring tones when there is incoming intercom calls to your extension.
- 5) Intercom Barge: To set whether to answer the incoming intercom calls during a conversation. If the option is enabled, when there is incoming intercom calls to your extension, if you are on an intercom conversation, it will refuse the call automatically; or it will put the current call on hold and put the incoming intercom call through.
- 6) Choose and set the different options by navigation keys and the Switch soft key.
- 7) Press the Save soft key to save your changes.

## During an Active Call

### Mute

This function allows you to mute the microphone of the active audio device during a call; you can not be heard by the other party. You can still hear all other parties while mute is enabled.

To mute/resume the conversation:

Press MUTE button during a conversation to mute all the conversations, the icon  will be shown on the LCD. Press it again to get the microphone return to normal conversation. When you press the MUTE button all of the conversation will be muted.

### Call Hold

This call function allows you to place an active call on hold. In this case your IP PBX might play a melody or message to the other party while waiting. Other calls can be received and made while having a call on hold.

To hold/resume a call:

- 1) Press the HOLD button or Hold hot key to put your active call on hold.
- 2) If there is only one call on hold, press the Resume hot key or Hold button to retrieve the call.
- 3) If there are more than one call on hold, press the line keys to switch the current account (The on hold calls are under different lines), or the Up/Down button to highlight the call (The on hold calls are under the same lines), then press the Resume hot key or Hold button to retrieve the call.

**Note:**

When you are under the call hold status, putting down the handset, the conversation

will go on over the speaker instead of hanging up the call.

## Call Waiting

This call feature allows your phone to accept other incoming calls to the extension no matter under which circumstances.

To enable/disable Call Waiting via Phone interface:

- 1) Press Menu->Features->Call Waiting hot keys.
- 2) Use the navigation keys or Disable/Enable hot key to active/inactive call waiting.



- 3) Use the navigation keys or Switch hot key to enable/disable the Play Tone option. This option used to define whether to play ring tones when there is call incoming during an active call.
- 4) Press Save hot keys to save the changes, or Back hot key to return to the previous menu.

To enable/disable Call Waiting via Web interface:

Choose Phone->Features->Call Waiting to do the relating changes.

## Call Transfer

You can customize your phone so that incoming calls are transferred directly to the third party such as another extension, mobile phone number, etc. There are three ways to transfer the call: Blind Transfer, Attended Transfer and Semi-Attended Transfer.

To Blind Transfer via phone interface:

- 1) A and B is on an conversation, A press TRAN Button or Tran hot key to put B on hold, then A can dial the third telephone number C (or press Directory soft key to enter the contact list, then choose a record) and press the Tran hot key to call out. A will turn to the hold status, and the LCD will display as Transferred.
- 2) After the C answered it, or A press the Cancel hot key to complete the transfer.
- 3) A will be disconnected from the call. B can talk to C.
- 4) If C refused to answer the call, it will prompt A that the transfer operation is failed. If the current mode is speaker, it will ring up; if the current mode is handset or headset, it will play ring tones for every five seconds. Pressing any function keys to exit the prompt interface. This function should be supported by server.

To Attended Transfer via phone interface:

- 1) A and B is on an conversation, A press TRAN Button or Tran hot key to put B on hold, then A can dial the third telephone number C (or press Directory soft key to enter the contact list, then choose a record) and press the OK or SEND button to call out.

- 2) After C answered it, A and C can have a private conversation without B hearing it, then A press the Tran button to complete the transfer.
- 3) A will be disconnected from the call. B can talk to C.

To Semi-Attended Transfer via phone interface:

- 1) A and B is on an conversation, A press the TRAN button or Transfer hot key to put B on hold, then A can dial a new number C (or press Directory soft key to enter the contact list, then choose a record) and press the OK or SEND button to call out.
- 2) While C is ringing, A hang up or press the Tran hot key. Then A will turn to the hold status, and the LCD will display as Transferred.
- 3) You will be disconnected from the call, when C pick up, B can talk to C.

**Note:**

Make sure that the SIP server you have registered supports this function.

### 3-way Conference

You can establish a three-party conference, during the conversation three phone parties can communicate with each other.

To establish a conference:

- 1) Press the Conf hot key during an active call.
- 2) The first call is placed on hold. You will hear a dial tone. Dial the number to conference in (or press Directory soft key to enter the contact list, then choose a contact to conference in) , then press the Send hot key.
- 3) When the call is answered, you can have a private conversation at first. And then press the CONF button, the conference call will include you and the other two parties.
- 4) During the conference, press the Split hot key to split the conference into two hold lines, and press the Resume hot key to resume the chosen call respectively.
- 5) When you press the hold key, the conference will be on hold.
- 6) Hang up to disconnect all parties.

### Network Conference

If you want to make a conference with more than three people, you can open the function of network conference.

If you enabled this function, you can put the meeting conference on the server.

To enable network conference via web interface:

- 1) Choose Account->Account X->Advance->Conference Type, there is a pull-down menu, choose network from the list.

Subscribe Register	Disabled	?
Subscribe for MWI	Disabled	?
MWI Subscription Period(Scope:0~84600) (seconds)	3600	
Caller ID Header	FROM	?
Use Session Timer	Disabled	?
Session Timer(seconds)		?
Refresher	Uac	?
Use user=phone	Disabled	?
Voice Encryption (SRTP)	<input type="radio"/> On <input checked="" type="radio"/> Off	?
ptime(ms)	20	?
BLF List URI		?
BLF List Code	*97	
Shared Line	Disabled	?
Dialog-Info Call Pickup	Disabled	?
BLA Number		?
BLA Subscription Period(Scope:60~7200)	300	?
SIP Send MAC	Disabled	?
SIP Send Line	Disabled	?
SIP Registration Retry Timer(Scope:0~1800) (seconds)	30	?
Enable Signal Encode	Disabled	
Signal Encode Key		
Conference Type	Local	
Conference URI	Local ATS Network	
ACD Subscription Period(120~3600)		

- 2) Enter the Conference URI.
- 3) Press Confirm button to save the changes.

To establish a conference:

- 1) Press the Conf hot key during an active call.
- 2) Dial the number to conference in, then press the Send hot key
- 3) When the call is answered, press the CONF button.
- 4) After starting a three way conference, press Conf button to enter Conference dialing interface and invite another party to participate in teleconference.
- 5) After starting conference, press Hold key to Hold local call without influencing others in conference.

## HuaWei ATS Conference

Turn on this function can make Multi-Party Conference come true; you can add or delete any attenders, also you can have a private chat with any member. This function needs the server's support.

To enable ATS conference via web interface:

- 1) Choose Account->Account X->Advance->Conference Type, there is a pull-down menu, choose ATS from the list.

Subscribe Register	Disabled	?
Subscribe for MWI	Disabled	?
MWI Subscription Period(Scope:0~84600) (seconds)	3600	
Caller ID Header	FROM	?
Use Session Timer	Disabled	?
Session Timer(seconds)		?
Refresher	Uac	?
Use user=phone	Disabled	?
Voice Encryption (SRTP)	<input type="checkbox"/> On <input checked="" type="checkbox"/> Off	?
ptime(ms)	20	?
BLF List URI		?
BLF List Code	*97	
Shared Line	Disabled	?
Dialog-Info Call Pickup	Disabled	?
BLA Number		?
BLA Subscription Period(Scope:60~7200)	300	?
SIP Send MAC	Disabled	?
SIP Send Line	Disabled	?
SIP Registration Retry Timer(Scope:0~1800) (seconds)	30	?
Enable Signal Encode	Disabled	
Signal Encode Key		
Conference Type	Local	
Conference URI	Local ATS Network	
ACD Subscription Period(120~3600)		

- 2) Enter the Conference URI.
- 3) Press Confirm button to save the changes.

To establish a conference:

- 1) Press the Conf hot key during an active call.
- 2) Dial the number to conference in, then press the Send hot key
- 3) When the call is answered, press the CONF button.
- 4) After the CONF is established, initiator can continually add CONF members, press Add hot key to enter into dial-up interface, enter the number, press send button to dial out, when the people answer the call, he have been attended to the CONF.
- 5) Initiator can use private chart function to have a private chart with any member, press PriChat, choose any members in phone member list, and then press PriChat hot key, both sides enter into private chart mode, if there only 3 CONF members, both sides begin to private chart and the third party enter a Hold mode. If the attender is more than 3, and then the other attenders keep on talking. If you want to end the private chat, press ExitPri hot key.
- 6) Initiator can use remove function to remove any CONF members, press remove hot key, choose any members in phone member list, and then press remove hot key again.
- 7) Initiator Hangs up, the CONF over.

## Message

The phone supports SMS (Short Messaging Service) and Voicemail, if you want to use them, please make sure that your VoIP telephony system supports this functionalities and your accounts' message has been enabled.

## Voicemail

Your voice mailbox messages, which are usually stored on a media server of your local or hosted VoIP telephony system, can be accessed from your phone.

New voice messages can be indicated both acoustically and visually as described below:

- The idle screen will indicate the new voice messages coming:
- The MESSAGE button will be lighted.

To configure the Voicemail code via Phone interface:

- 1) Press Menu->Messages->Voice Mail->Set Voice Mail .
- 2) Use the navigation keys to highlight the line for which you want to set, enter the code which the phone uses to connect to your system. Press 123 hot key to choose the proper input method.
- 3) Press Save to save the change, press Back to return to the previous menu.

**Note:**

Please contact your system administrator for the connecting code. Different systems have different codes.

Want to see amount of Voice mail via phone interface, must enable the Subscribe for MWI via the web interface at first.

- 1) Choose Account->Advanced-> Subscribe for MWI.
- 2) Choose enable in the pull-down menu.

Codexes >> ?	
<b>Advanced &gt;&gt;</b>	
UDP Keep-alive Message	Enabled ?
UDP Keep-alive Interval(seconds)	30
Login Expire(seconds)	3600 ?
	5060 ?
RPort	Disabled ?
SIP Session Timer(seconds) T1	0.5 ?
SIP Session Timer(seconds) T2	4
SIP Session Timer(seconds) T4	5
Subscribe Period(seconds)	1800 ?
DTMF Type	RFC2833 ?
How to INFO DTMF	Disabled
DTMF Payload(Scope:96~255)	101
100 reliable retransmission	Disabled ?
Enable Precondition	Disabled ?
Subscribe Register	Disabled ?
Subscribe for MWI	Disabled ?
MWI Subscription Period(Scope:0~84600) (seconds)	3600
Caller ID Header	FROM ?
Use Session Timer	Disabled ?
Session Timer(seconds)	
Refresher	Uac ?
Use user=phone	Disabled ?
Voice Encryption (SRTP)	<input type="checkbox"/> On <input checked="" type="checkbox"/> Off ?
ptime(ms)	20 ?

The device sends a Subscribe packet to the server to subscribe Message waiting, the device will send a Subscribe packet to the server after registration

which will be used for Caller ID display.

**Register Name**  
SIP service subscriber's ID used for authentication.

**User Name**  
User account, provided by VoIP service provider.

**NAT Traversal**  
Defines the STUN server will be active or not.

**Proxy Require**  
A special parameter just for Nortel server. If you login to Nortel server, the value should be:  
com.nortelnetworks.firewall

**Codexes**  
Choose the codexes you want to use.

**Advanced**  
The Advanced parameters for administrator.

To view the voicemail via the Phone interface:

- 1) Press Menu->Messages->Voice Mail->View Voice Mail.

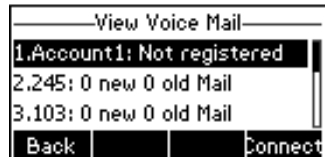

- 2) You can view the amount of the voice mail that includes new or old voice mail.
- 3) Choose the account and press the Connect button, then you are able to listen to your new and old messages.

To retrieve the new voicemail via the Phone interface:

- 1) Press the Voicemail hot key directly.
- 2) You may be prompted to enter the password which is needed to connect to your VoIP telephony system. It depends on your system.
- 3) Your voice mailbox is called and you are able to listen to your new and old messages.

**Note:**

Before retrieving the new voicemail, please make sure that the connecting code has been set on the phone.

## SMS

You can retrieve the SMS in the same way as Voicemail.

To retrieve the SMS via Phone interface:

- 1) Press Menu->Messages->Text Message to enter the configuration interface.
- 2) Use the navigation hot key to highlight the options. You can read the message in the Inbox/Sentbox/Outbox/Draftbox.



- 3) Press View hot key to open and read the specific message.

To reply the SMS via Phone interface:

- 1) After retrieving the specific message, press Reply hot key, use the abc hot key to change the input method.

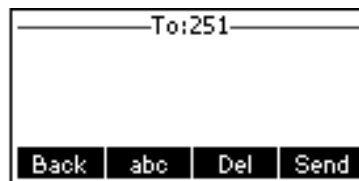

- 2) (Optional) If multiple lines are configured on your phone, select from which line messages are to be retrieved from the list using the navigation keys and Messages appear first to last in sent order.
- 3) Press Send hot key, you are required to choose an account which is used to send out the message and the number you want to send to.
- 4) Press Send hot key to send out the message, or Back hot key to return to the previous menu.

To edit a new message via the Phone interface:

- 1) Press Menu->Messages->Text Message->New Message to enter.



- 2) Edit the new message; use the abc hot key to change the Input Method.
- 3) (Optional) If multiple lines are configured on your phone, select from which line messages are to be retrieved from the list using the navigation keys and Messages



appear first to last in sent order.

- 4) Press Send hot key to send out the message, or Back hot key to return to the previous menu.

To delete the message via the Phone interface:

- 1) After retrieving the specific message, press Delete hot key.
- 2) You are prompted to confirm the Delete, press Yes hot key to delete the message, press No hot key to return to previous menu.



To edit the message via Web interface:

- 1) Choose Phone->SMS
- 2) Enter the account information, target phone number, message content.
- 3) Press Send button to send out the message, or Cancel button to cancel the operation.

**Note:**

You can not perform the messaging via Web interface except edit Message.

# Using the Advanced Phone Functions

## Account Setting

Please refer to the previous part "Configuration and Registration" for the basic Account setting information. The following table lists the instruction of the field about the advanced Account Setting.

Field Name	Description
<i>UDP Keep-alive Message</i>	Defines whether to active the phone UDP Keep-alive mechanism. The default is Enabled.
<i>UDP Keep-alive Interval(seconds)</i>	This parameter specifies how often the phone will send a packet to the SIP server. Default is 30 seconds.
<i>Login Expire(seconds)</i>	This parameter specifies the time frequency that phone refreshes its registration. The default interval is 3600 seconds.
<i>Local SIP Port</i>	Local SIP port. The default value is 5060.
<i>Local RTP Port</i>	Defines the local RTP port that the phone will listen and transmit. The default value is 11780.
<i>RPort</i>	The parameter allows you configuring the proxy to send responses back to a particular address and port. The default is disabled.
<i>SIP Session Timer</i>	This document defines an extension to the Session Initiation Protocol (SIP). This extension allows for a periodic refresh of SIP sessions through a re-INVITE or UPDATE request. The refresh allows both user agents and proxies to determine if the SIP session is still active.
<i>Subscribe Period(seconds)</i>	This parameter could set the period of the subscription. The default value is 3600.
<i>DTMF Type</i>	Select the DTMF type.

You can only configure these settings via Web interface.

- 1) Choose Account.
- 2) Select the desired account.
- 3) Choose Advanced interface to do the relating settings.

You can consult your system administrator for more information.

## TLS

TLS(Transport Layer Security), an IETF standards track protocol(RFC 5246), was based on the earlier SSL specifications developed by Netscape Corporation.

If you make a call based on TLS and SRTP (Set the transport as TLS and the SRTP as On), the IP phone UI will display the connecting and ring back interface. If the reception also set the transport as TLS, then IP Phone UI will display the icon  on both side.

Go to Account->Basic, choose Transport option, in the pull-down menu, you can choose the TLS option, and then click the Confirm button to save the change.

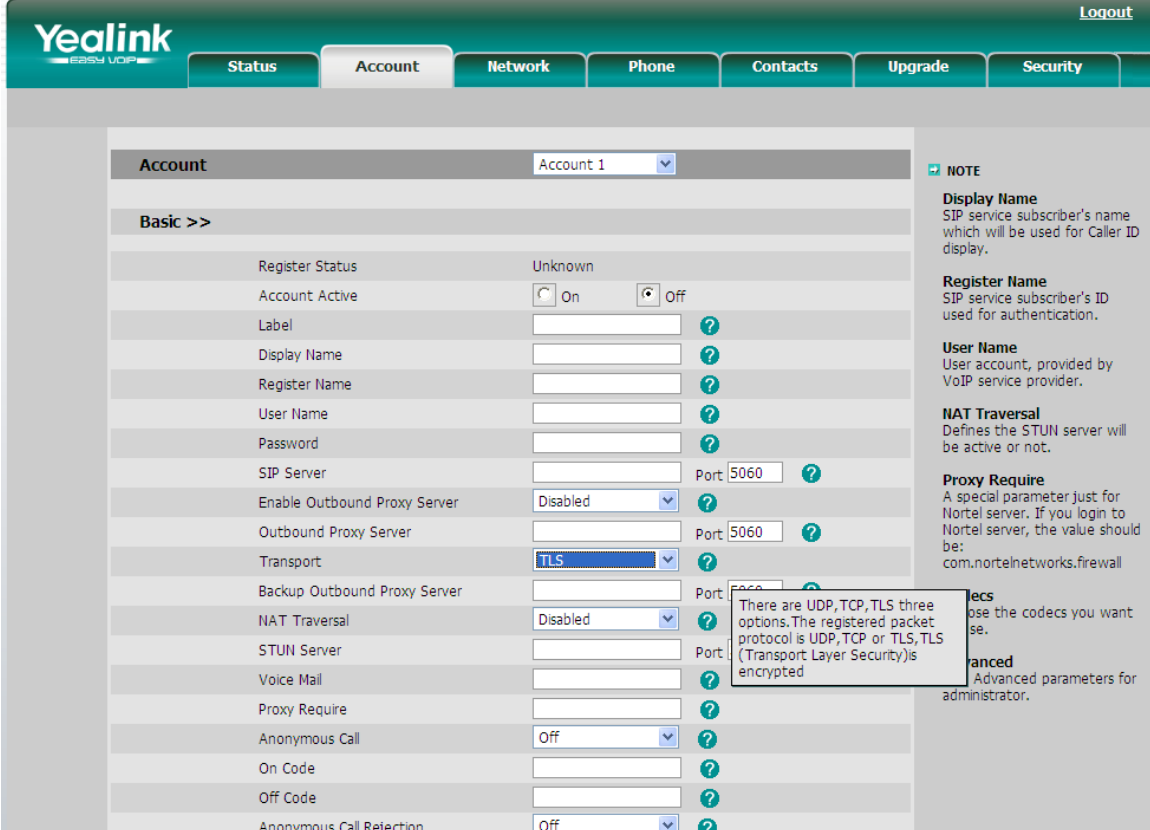

The screenshot shows the Yealink web interface for account configuration. The 'Account' tab is active, and the 'Basic' sub-tab is selected. The 'Transport' dropdown menu is open, showing 'TLS' as the selected option. A tooltip is visible over the 'Transport' dropdown, stating: "There are UDP, TCP, TLS three options. The registered packet protocol is UDP, TCP or TLS, TLS (Transport Layer Security) is encrypted." The interface includes various configuration fields such as Register Status, Account Active, Label, Display Name, Register Name, User Name, Password, SIP Server, Enable Outbound Proxy Server, Outbound Proxy Server, Backup Outbound Proxy Server, NAT Traversal, STUN Server, Voice Mail, Proxy Require, Anonymous Call, On Code, Off Code, and Anonymous Call Rejection. A 'NOTE' section on the right provides additional information about Display Name, Register Name, User Name, NAT Traversal, and Proxy Require.

## DNS-SRV

If the SIP server cannot be used, the phone will be connected on the server which is available.

To set DNS-SRV via web interface:

Go to Account->Basic, choose Transport option, in the pull-down menu, you can choose the DNS-SRV option, and then click the Confirm button to save the change.

**Account** Account 1

**Basic >>**

Register Status: Unknown

Account Active:  On  Off

Label:

Display Name:

Register Name:

User Name:

Password:

SIP Server:  Port: 5060

Enable Outbound Proxy Server: Disabled

Outbound Proxy Server:  Port: 5060

Transport: DNS-SRV

Backup Outbound Proxy Server:  Port: 5060

NAT Traversal:

STUN Server:  Port: 3478

Voice Mail:

Proxy Require:

Anonymous Call: Off

On Code:

Off Code:

Anonymous Call Rejection: Off

**NOTE**

**Display Name**  
SIP service subscriber's name which will be used for Caller ID display.

**Register Name**  
SIP service subscriber's ID used for authentication.

**User Name**  
User account, provided by VoIP service provider.

**NAT Traversal**  
Defines the STUN server will be active or not.

**Proxy Require**  
A special parameter just for Nortel server. If you login to Nortel server, the value should be: com.nortelnetworks.firewall

**Codecs**  
Choose the codecs you want to use.

**Advanced**  
The Advanced parameters for administrator.

## Network Setting

### PC Port Setting

Please refer to the previous part "Configuration and Registration" for the basic Network WAN setting information. The following table lists the instructions of the field about the Network PC Port Setting.

Field Name	Description
<i>As Bridge</i>	If you select the Bridge mode, then the two Fast Ethernet ports will be transparent.
<i>As Router</i>	If you select the Router mode, the SIP phone will work as a router.
<i>IP address</i>	User could configure the PC port IP address.
<i>DHCP Server</i>	If you set the DHCP server on, the device connected to the PC port will get the IP address automatically between the start IP address and the end IP address. But if you select the bridge mode, the DHCP server can not work.
<i>Start IP Address</i>	Indicate the range of the IP address.
<i>End IP Address</i>	Indicate the range of the IP address.

To configure PC Port settings via Phone interface:

- 1) Press Menu->Settings->Advanced Settings.
- 2) Enter the password required, scroll to Network option, then press Enter hot key, select PC port and press Enter hot key.

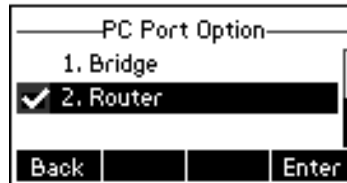

- 3) If you choose Bridge, it will return to the previous menu.
- 4) If you choose Router, you will be prompted to enter the IP Address, Subnet Mask, DHCP Server Disable/Enable.
- 5) Press Save hot key to save the changes, or Back hot key to return to the previous menu.

To configure PC Port settings via Web interface:

Choose Network-> PC Port to do the relating configuration. You can consult your system administrator for more information.

## VLAN Setting

VLAN is a group of hosts with a common set of requirements that communicate as if they were attached to the Broadcast domain, regardless of their physical location. The following table lists the instruction of the field about the VLAN Setting.

Field Name	Description
QoS	When the network capacity is insufficient, QoS could provide priority to users by setting the value.
Local RTP Port	Define the port for voice transmission.
WebServer	Users can choose the WebServer type: Disable, HTTP, HTTPS, or HTTPS & HTTP.

To configure VLAN settings via Phone interface:

- 1) Press Menu->Settings->Advanced Settings.
- 2) Enter the password required, scroll to Network option, then press Enter hot key, select VLAN and press Enter hot key.

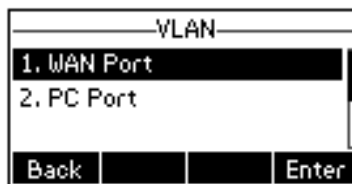

- 3) Choose WAN Port, press Enter hot key.

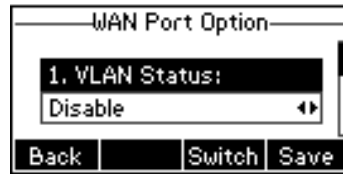

- 4) Set the VLAN Status, and input the VID Number, Priority.
- 5) Press Save hot key to save the settings, or Back hot key to return to VLAN menu.
- 6) Follow the same way to set the PC Port option.

To configure VLAN settings via Web interface:

Choose Network->Advanced to do the relating configuration. You can consult your system administrator for more information.

## LLDP

The Link Layer Discovery Protocol (LLDP) is a vendor-neutral Layer 2 protocol that allows a network device to advertise its identity and capabilities on the local network.

Enable LLDP function; the phone will go to switch to get related VLAN parameters automatically. (Synchronous with VLAN in switch)

To configure LLDP settings via Web interface:

- 1) Choose Network->Advanced->LLDP->Active option, in the pull-down menu, choose enable.
- 2) Then enter the corresponding Packet Interval in Packet Interval field.
- 3) You can also disable this function when you choose disable in active field.
- 4) Click the Confirm button to save the change.

The screenshot shows the Yealink web interface with the 'Network' tab selected. The interface is divided into several sections:

- LLDP**: Active (Disabled), Packet Interval (120, Scope: 1~3600s).
- VLAN**: WAN Port Active (Disabled), VID (0, 0-4094), USRPRIORITY (0); PC Port Active (Disabled), VID (0, 0-4094), USRPRIORITY (0).
- Port Link**: WAN Port Link (auto negotiat), PC Port Link (auto negotiat).
- VPN**: VPN Active (Disabled), Upload VPN Config (Browse...), Import button.
- Voice QoS**: Voice QoS (40, 0~63), SIP QoS (40, 0~63).

On the right side, there is a **NOTE** section:

- VLAN**: A VLAN is a logical local area network (or LAN) that extends beyond a single traditional LAN to a group of LAN segments, given specific configurations.
- QoS**: When the network capacity is insufficient, QoS could provide priority to users by setting the value.
- Local RTP Port**: Define the port for voice transmission.

## HTTPS

This IP phone can support HTTPS (Hypertext Transfer Protocol over Secure Socket Layer). Adding SSL layer under HTTP, in short, it is a security version of HTTP. Users can set this transmission mode via web page.

To configure HTTPS settings via Phone interface:

- 1) Press Menu->Settings->Advanced Settings.
- 2) Enter the password required, scroll to Network option, press Enter hot key, select Webserver Type option, then press Enter hot key again.

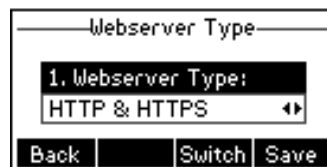

- 3) Press the navigation keys or Switch hot key to choose the transmission mode.
- 4) Press Save hot key to save the settings, or Back hot key to return to Webserver Type menu.

To configure HTTPS settings via Web interface:

Go to Network->Advanced, choose WebServer option, in the pull-down menu of Type field, choose the transmission mode, and then click the Confirm button to save the changes.

<b>VLAN</b> ?		
WAN Port	Active	Disabled
	VID	0 (0-4094)
	USRRIORITY	0
PC Port	Active	Disabled
	VID	0 (0-4094)
	USRRIORITY	0
<b>Port Link</b>		
	WAN Port Link	auto negotiat
	PC Port Link	auto negotiat
<b>Voice QoS</b> ?		
	Voice QoS	40 (0~63)
	SIP QoS	40 (0~63)
<b>Local RTP Port</b> ?		
	MaxRTPPort	11800 (0~65535)
	MinRTPPort	11780 (0~65535)
<b>WebServer</b> ?		
	HTTP port	80 (1~65535)
	HTTPS port	443 (1~65535)
	Type	HTTP&HTTPS
<b>802.1x</b> ?		
	802.1X Mode	<input type="checkbox"/> Disabled <input checked="" type="checkbox"/> HTTP&HTTPS <input type="checkbox"/> HTTP Only <input type="checkbox"/> HTTPS Only

area network (or LAN) that extends beyond a single traditional LAN to a group of LAN segments, given specific configurations.

**QoS**  
When the network capacity is insufficient, QoS could provide priority to users by setting the value.

**Local RTP Port**  
Define the port for voice transmission.

**Note:**

1. For more details of the HTTPS, you can consult with your system administrator.
2. IP phone also support Internet Protocol Version 6.

## Maintenance Tasks

### Administrator Mode

The phone allows two modes to configure the phone:

- User Mode
- Administrator Mode

Administrator mode grants unlimited access to the phone configuration on both Web and Phone interface. User Mode is not able to access the settings on the Phone interface such as: Accounts, Network, Reset to Factory, other advance phone settings.

### Administrator/User Password

Administrator mode grants unlimited access to the phone configuration on both web and phone user interface. The administrator/user password is used to access:

- Web interface.
- the advanced settings of the phone such as Network, Account, Reset to Factory



Settings via the Phone interface.

The default administrator password is **admin**. Meanwhile the user name for Web interface access is **admin**.

To change the administrator password via phone interface:

- 1) Press the Menu ->Settings-> Advanced Settings.
- 2) You are prompted to enter the required password, the default one is **admin**.
- 3) Scroll to Set Password, press Enter hot key.
- 4) You are prompted to enter the Current, New and Confirm password, Press abc hot key to change the input method.
- 5) Press Save hot key to confirm the change, or Back hot key to return to the previous menu.

To change the administrator password via web interface:

Choose Security->Password->admin, enter the Current, New and Confirm password, click Confirm button to save the changes, or Cancel button to cancel the changes.

To logout via Web interface:

Click the Logout button in the top right corner.

## Reboot

You should reboot the phone when you are challenged, e.g. after applying changes to the phone configuration.

To reboot via Web interface:

- 1) Choose Upgrade->Basic.
- 2) Click Reboot button.
- 3) You are prompted to confirm the change, press OK to confirm the changes, press Cancel to cancel the operation.

**Note:**

Please do not power off during reboot, or it will cause the flash memory error.

## Reset to Factory

You should reset the phone only in this case: the phone configuration was changed and the phone is not functioning anymore. To maintain the configuration of the phone, you need your system administrator or service provider's advice.

To reset to factory via phone interface:

- 1) Press the Menu->Settings->Advanced Settings
- 2) You are prompted to enter the required password, the default one is **admin**.
- 3) Scroll to Reset to factory option, and press Enter hot key to enter the configuration interface.

- 4) You are prompted to confirm the change, press OK hot key to reset to factory settings, or press Cancel hot key to return to previous menu.



- 5) It will take a few minutes to reset, please do not power off during resetting, or it will cause flash memory error.

**Note:**

The reset to factory option must in the admin mode.

To reset to factory via Web interface:

- 1) Choose Upgrade->Basic.
- 2) Click Reset button.
- 3) You are prompted to confirm the change, press OK to confirm the changes, press Cancel to cancel the operation.

**Note:**

If you confirm all current setting changes including contact list, call history, account settings, etc will be lost, you need to export the configuration first if you still want to import the old configurations after reset. Or your phone must be configured a new manually unless mass provisioning is used!

To Export/Import the old configuration file via Web interface:

- 1) Choose Upgrade->Advanced, select Import/Export Configuration, choose Export button to export the file to your local computer.
- 2) Choose Upgrade->Advanced, select Import/Export Configuration, choose Browse button, select the specific configuration file in your local computer, choose Import button.
- 3) It will take a few minutes to reset, please do not power off during resetting, or it will cause flash memory error.

## Firmware Update

The phone is delivered with pre-installed firmware which allows operating your phone flawlessly. If you require updating the phone's firmware please contact your system administrator. You can only update the firmware via Web interface.

**Warning:**

1. Please do not power off or unplug the Ethernet cable during the updating.

To update the firmware manually via Web interface:

- 1) Choose Upgrade->Basic->Browse, select the firmware file in your local computer.
- 2) Click Upgrade button to update the new firmware.

To update the firmware automatically via Web interface:

- 1) Choose Upgrade->Advanced, configure the relating settings: Custom Option, Custom Option Type, URL, Account, Password, Common AES Key and MAC-Oriented AES Key, PNP config and Check New Config etc.
- 2) Choose Confirm button, the phone will check the server for a new firmware in a specific time, and it updates automatically if there is new firmware.
- 3) You can also update the firmware immediately by pressing Auto-provision button.

Set Auto Provision via phone interface:

- 1) Go to Menu->Settings->Advanced Settings-> Auto Provision.
- 2) Enter the URL, User Name and Password.
- 3) Click the Save hot key to save the changes.

**Note:**

1. Any power interruption during the following process will most likely lead to a flash memory error. As a result the system cannot boot up anymore..
2. The upgrade priority is PNP, Custom Option, URL by descending.
3. Users can also delete some configuration options by Auto-provision, for example, to delete the admin password.

## Decryption

This IP phone can support y00000000005.cfg and mac.cfg files encryption and decryption for user authentication to realize security usage. If there are any encrypted y00000000005.cfg or mac.cfg files on the server, users can open the webpage of your IP phone. Go to Upgrade->Advanced, choose and fill in the Common AES Key (for y00000000005.cfg, should be 16 bit) and MAC-Oriented AES Key (for mac.cfg, should be 16 bit) option, then click the Confirm button to decryption the files and upgrade to the new version. Shown as below:

**Note:**

You can ask your system administrator for the decrypt password.

Set AES Key via phone interface:

- 1) Go to Menu->Settings->Advanced Settings->Set AES Key.



- 2) Enter the Common AES and the MAC-oriented option.
- 3) Press the Save hot key to save the changes.

**Zero-sp-touch**

Zero-sp-touch this function can help users to configure AUTOP and network parameters quickly.

Enable this function, when the power is on or press the corresponding DSSKEY, the phone will turn to the zero-sp-touch interface.

Turn on Zero-sp-touch via web interface:

- 1) Choose Upgrade->Advanced->Zero Active, in the pull-down menu, choose enable to turn on this function.

- 2) Click Confirm to save.

The screenshot shows the Yealink web interface with the 'Advanced' tab selected. The configuration options are as follows:

- Custom Option(128 ~ 254): [Text Input] ?
- Custom Option Type: String ?
- URL: [Text Input] ?
- Account: [Text Input] ?
- Password: [Text Input] ?
- Common AES Key: [Text Input] ?
- MAC-Oriented AES Key: [Text Input] ?
- ForbidZero: Enabled ?
- WaitTime: 5
- PNP Config: Enabled ?
- Check New Config: Disabled ?
- Click this button to auto provision immediately: Auto provision ?
- Export / Import Config: [Text Input] 浏览... ?
  - Import
  - Export
- Export System Log: Local ?
  - Export
- PCAP Trace: Start Stop Export ?

NOTE:

- Custom Option**: Specify the DHCP Option that you want to use for provisioning. Refer to Auto Provision Manual for details about provisioning.
- AES Key**: It is provided by ISP.
- Click this button to auto provision immediately**: Click this button to auto provision immediately.
- Export/Import Config**: Export the configuration files to backup the settings, and could import all the settings after reset.
- System Log**: There are two methods to export the system log, Local or Server.

Enter into zero-sp-touch interface, first a countdown interface come into view,

- 1) Not any operation or press cancel hot key, will enter idle interface.
- 2) Press status key enters into phone's network interface, can search the internet.
- 3) Press OK key, enter a network setting interface, press next key enter an AutoP setting interface, enter the corresponding contents; press OK key to save the settings. Press back key return to previous menu.

## System Log Export

If there are any errors happened in your phone, you can export the system log and send to your system administrator for diagnosis.

To export the System Log:

- 1) Choose Upgrade->Advanced, select Export System Log type, if the type is Local, it will export the syslog directly; if the type is server, it will export the syslog to the specified server.
- 2) Click Export button to export the file

## PCAP Trace Export

The PCAP Trace used to record the data transport of your IP phone. If there are any errors happened in your phone, you can export the PCAP trace and send to your system

administrator for diagnosis.

To export the PCAP Trace:

Choose Upgrade->Advanced to enter, select PCAP Trace option, click Start button began to capture the trace, and click Stop to stop capture the trace, and then click Export to export the file to your local computer.

## **802.1X**

IEEE 802.1X is an IEEE Standard for port-based Network Access Control (PNAC). It is part of the IEEE 802.1 group of networking protocols. It provides an authentication mechanism to devices wishing to attach to a LAN, either establishing a point-to-point connection or preventing it if authentication fails. It is used for securing wireless 802.1X access points and is based on the Extensible Authentication Protocol (EAP).

This IP phone can support 802.1X. For the details, please consult your system administrator.

## **DSS keys Configuration**

The phone has 3 line keys which are able to set up to 35 functions per key. The following list shows the functions you can set on the DSS keys and provides a description for each function. The default configuration for each key is Line.

- N/A
- Conference
- Forward
- Transfer
- Hold
- DND
- Redial
- Call Return
- SMS
- Pick Up
- Call Park
- DTMF
- Voice Mail
- Speed Dial
- Intercom
- Line
- BLF
- URL
- Group Listening
- Public Hold
- Private Hold

- Shared Line
- XML Group
- Group Pickup
- Paging
- Record
- Xml Browser
- Hot Desking
  
- URL Record
- LDAP
  
- BLF List
  
- Prefix
  
- Zero-sp-touch
- ACD
- Local Group
- Broadsoft Group

**Note:**

1. Quick access features like Intercom and Voicemail must first be configured on your PBX in order to work on your phone. See your system administrator for more information.

**Conference**

You are allowed to configure the DSS key to be used as a conference key while remaining in the current call. This key allows a user on a call to conference another party while remaining in the conference.

To assign the key as Conference:

- 1) Choose Phone->DSS Key-> Line Key, choose one of the keys you want to make the assignment, there is a pull-down menu in the Type field, choose Conference from the list.
- 2) Press Confirm button to save the changes.

**Forward**

If the key is configured as Forward key, press this key under the idle status, the IP phone will turn to the forward page, and you can set the Forward to number, then when there is any call to the extension number will be forwarded to the set number automatically.

To assign the key as Forward:

- 1) Choose Phone->DSS Key-> Line Key, choose one of the keys you want to make the assignment, there is a pull-down menu in the Type field, choose Forward from the list.
- 2) Enter the extension number you want to forward to in the Extension field.

- 3) Press Confirm button to save the changes.

## **Transfer**

You are able to configure the key as a transfer key to perform the Blind/Attended/Semi-Attended Transfer.

To assign the key as Transfer:

- 1) Choose Phone->DSS Key-> Line Key, choose one of the keys you want to make the assignment, there is a pull-down menu in the Type field, and choose Transfer from the list.
- 2) Enter the Number in the "Value" field, when you are on a conversation, press this key, the phone will Blind transfer to the number. Or you can leave it blank to set as the transfer button.
- 3) Press Confirm button to save the changes.

## **Hold**

The key can be configured as a hold key. You can use this key to hold and retrieve a call during the conversation.

To assign the key as Hold:

- 6) Choose Phone->DSS Key-> Line Key, choose one of the keys you want to make the assignment, there is a pull-down menu in the Type field, choose Hold from the list.
- 7) Press Confirm button to save the changes.

## **DND**

If the key is configured as DND key, you are allowed to active the DND function immediately when you press it. Press it again to deactivate DND mode.

To assign the key as DND:

- 1) Choose Phone->DSS Key-> Line Key, choose one of the keys you want to make the assignment, there is a pull-down menu in the Type field, choose DND from the list.
- 2) Press Confirm button to save the changes.

## **Redial**

If the key is configured as Redial key, press this key under the idle status, it will enter the Dialed Calls interface, then you can choose a special line to call out by pressing the line keys.

To assign the key as Redial:

- 1) Choose Phone->DSS Key-> Line Key, choose one of the keys you want to make the assignment, there is a pull-down menu in the Type field, choose Redial from the list.
- 2) Press Confirm button to save the changes.



## **Call Return**

When the key is configured as Call Return key you are allowed to dial out the last phone call you received.

To assign the key as Call Return:

- 1) Choose Phone->DSS Key-> Line Key, choose one of the keys you want to make the assignment, there is a pull-down menu in the Type field, choose Call Return from the list.
- 2) Press Confirm button to save the changes.

## **SMS**

When the key is configured as SMS key you are allowed to access SMS quickly by pressing this key.

To assign the key as SMS:

- 1) Choose Phone->DSS Key-> Line Key, choose one of the keys you want to make the assignment, there is a pull-down menu in the Type field, choose SMS from the list.
- 2) Press Confirm button to save the changes.

## **Pick Up**

When you configure a Pick Up key, you specify the extension that you want to monitor. Then, when the monitored extension receives a call, you can press this key to pick up the incoming calls.

To assign the key as Pick Up:

- 1) Choose Phone->DSS Key-> Line Key, choose one of the keys you want to make the assignment, there is a pull-down menu in the Type field, choose Pick Up option from the list.
- 2) Enter the feature code (for example, input \*78345, \*78 is the feature code and the 345 is the extension number you want to pickup) in the Value field.
- 3) In the "Line" field, select a line for which to apply this key.
- 4) Press Confirm button to save the changes.

## **Call Park**

Call Park is a feature that allows a person to put a call on hold at one telephone set and continue the conversation from any other telephone set.

The "call park" feature is activated by pressing a preprogrammed button or a special sequence of buttons. When the conversation which is monitored was transferred to an unused extension number, you can press this key to retrieve the call.

To assign the key as Call Park:

- 1) Choose Phone->DSS Key-> Line Key, choose one of the keys you want to make the assignment, there is a pull-down menu in the Type field, choose Call Park from the list.
- 2) Enter the number you want to park in the Value field.
- 3) In the "Line" field, select a line for which to apply this key.
- 4) Press Confirm button to save the changes.

## **DTMF**

You are allowed to send out the desired DTMF number during the conversation. The number needs to be set in advance.

To assign the key as DTMF:

- 1) Choose Phone->DSS Key-> Line Key, choose one of the keys you want to make the assignment, there is a pull-down menu in the Type field, choose DTMF from the list.
- 2) In the "Value" field, enter the specific number.
- 3) Press Confirm button to save the changes.

## **Voice Mail**

When the key is configured as Voicemail key you are allowed to access voicemail quickly by pressing this key.

To assign the key as Voice Mail:

- 1) Choose Phone->DSS Key-> Line Key, choose one of the keys you want to make the assignment, there is a pull-down menu in the Type field, choose Voice Mail from the list.
- 2) Enter the number you want to set as the voice mail box in the Value field.
- 3) In the "Line" field, select a line for which to apply this key.
- 4) Press Confirm button to save the changes.

## **Speed Dial**

You can configure the key as a simplified speed dial key. This key function allows you to easily access the most frequently dialed numbers.

To assign the key as Speed Dial:

- 1) Choose Phone->DSS Key-> Line Key, choose one of the keys you want to make the assignment, there is a pull-down menu in the Type field, choose Speed Dial from the list.
- 2) Enter the number you want to perform Speed Dial in the Value field.
- 3) In the "Line" field, select a line for which to apply this key.
- 4) Press Confirm button to save the changes.

## Intercom

You can configure the key for Intercom mode and is useful in an office environment as a quick access to connect to the operator or the secretary.

To assign the key as Intercom:

- 1) Choose Phone->DSS Key-> Line Key, choose one of the keys you want to make the assignment, there is a pull-down menu in the Type field, choose Intercom from the list.
- 2) Enter the extension number you want to intercom in the Value field.
- 3) In the "Line" field, select a line for which to apply this key, the default one is Line 1.
- 4) Press Confirm button to save the changes.

**Note:**

Your VoIP PBX must support this feature. And make sure the Intercom Allow is enable.

## Line

You can set these keys as line keys to active up to the three user accounts.

To assign the key as Line:

Choose Phone->DSS Key-> Line Key, choose one of the link key you want to make the assignment, there is a pull-down menu in the Type field, choose Line from the list, press Confirm button to save the changes.

## BLF

You can configure the key for Busy Lamp Field (BLF) which allows you to monitor the status (idle, ringing, or busy) of other SIP accounts. User can dial out on a BLF configured key.

To assign the key as BLF:

- 1) Choose Phone->DSS Key-> Line Key, choose one of the keys you want to make the assignment, there is a pull-down menu in the Type field, and choose BLF from the list.
- 2) Enter the number you want to monitor in the Value field,
- 3) In the "Line" field, select a line for which to apply this key.
- 4) And then enter the feature codes in the extension field.
- 5) Press Confirm button to save the changes.

Please refer to "LED Instruction" for more details about the LED status in different situation.

**Note:**

In the Web interface, you can also set the pickup number to active the pickup function. For example, if you set the BLF number as 212, and the pickup number is \*83, then

when there is an incoming call to 212, press the BLF key, it will call out the \*83 automatically to pickup the incoming call on 212.

## **URL**

If the key is configured as URL, then pressing this key, you can send HTTP requests to a web server.

To assign the key as URL:

- 1) Choose Phone->DSS Key->Line Key, choose one of the keys you want to make the assignment, there is a pull-down menu in the Type field, and choose URL from the list.
- 2) Enter the number you want to set as URL in the Value field.
- 3) Press Confirm button to save the changes.

## **Group Listening**

When the key is configured as Group Listening key, you are allowed to enable the Speakerphone and Handset/Headset mode at the same time. It is suitable for the group conversation which has more than one person at one side. You are able to speak and listen using handset/headset; meanwhile the others nearby can listen using speakerphone. You can get back to the previous mode by pressing the key again. (If the current mode is handset or headset, users can press the speaker button to open or close the group listening function)

To assign the key as Group Listening:

- 1) Choose Phone->DSS Key-> Line Key, choose one of the keys you want to make the assignment, there is a pull-down menu in the Type field, and choose Group Listening from the list.
- 2) Press Confirm button to save the changes.

## **Public Hold**

The key can be configured as a public hold key. During a conversation, all members belonging to that particular BLA group can use this key to hold or retrieve a call.

To assign the key as Public Hold:

- 1) Choose Phone->DSS Key->Line Key, choose one of the keys you want to make the assignment, there is a pull-down menu in the Type field, choose Public Hold from the list.
- 2) Press Confirm button to save the changes.

## **Private Hold**

The key can be configured as a private hold key. During a conversation, all members

belonging to that particular BLA group can use this key to hold the call, but only the initiator can retrieve the call.

To assign the key as Private Hold:

- 1) Choose Phone->DSS Key->Line Key, choose one of the keys you want to make the assignment, there is a pull-down menu in the Type field, choose Private Hold from the list.
- 2) Press Confirm button to save the changes.

## **Shared Line**

The Shared Line Appearances (SLA, which is also named as BLA) feature allows subscribers to share SIP lines and also provides status monitoring of the shared line. When a user places an outgoing call using such an appearance, all members belonging to that particular SLA group are notified of this usage and are blocked from using this line appearance until the line goes back to idle state or when the call is placed on hold. Similarly all members of the SLA group are notified of an incoming call and the call can be picked up on a line appearance associated with the SLA extension.

To assign the key as Shared Line:

- 1) Choose Phone->DSS Key->Line Key, choose one of the keys you want to make the assignment, there is a pull-down menu in the Type field, choose Shared Line from the list.
- 2) Enter the condition code in the Value field.
- 3) In the "Line" field, select a line for which to apply this key, the default one is Line 1.
- 4) Press Confirm button to save the changes.

## **XML Group**

The keys can be configured as XML Group key. Then pressing this key under the idle status, you can enter the XML Group interface.

To assign the key as XML Group:

- 1) Choose Phone->DSS Key-> Line Key, choose one of the keys you want to make the assignment, there is a pull-down menu in the Type field, choose XML Group from the list.
- 2) In the Line field, choose a remote phone book to specify the record, so you must configure the remote phone book at first.
- 3) Press Confirm button to save the changes.

## **Group Pick up**

When you configure a Group Pick Up key, you specify the extension group that you want to monitor. Then, when the monitored group receives a call, you can press this key to pick up the incoming call. If the group receives multiple calls simultaneously, you will pick up the specific one the server assigns to you.

To assign the key as Group Pick Up:

- 1) Choose Phone->DSS Key-> Line Key, choose one of the keys you want to make the assignment, there is a pull-down menu in the Type field, and choose Group Pick Up option from the list.
- 2) Enter the feature code (for example,\*78) in the Value field.
- 3) In the "Line" field, select a line for which to apply this key.
- 4) Press Confirm button to save the changes.

## **Paging**

You can configure the key as Paging key. When you press this key, the phone will dial the number out directly.

To assign the key as Paging:

- 1) Choose Phone->DSS Key-> Line Key, choose one of the keys you want to make the assignment, there is a pull-down menu in the Type field, choose Paging option from the list.
- 2) Enter the number you want to dial out directly in the Value field.
- 3) In the "Line" field, select a line for which to apply this key.
- 4) Press Confirm button to save the changes.

## **Record**

Call recording is a phone function to record the conversation in the process of dialogue. Using this feature, please pay attention to the maximum recording time and frequency in advance. Generally, it maybe a few minutes.

To assign the key as Record:

- 1) Choose Phone->DSS Key-> Line Key, choose one of the keys you want to make the assignment, there is a pull-down menu in the Type field, choose Record option from the list.
- 2) Press Confirm button to save the changes.

## **Xml Browser**

Xml browser is a simple browser function, which is based on xml language and http/https service, users can use tools such as php, javascript, etc., accordance with the established syntax, to generate server-side functions dynamically to meet the needs of the user xml file, and then downloaded it to sip phone by http/https, so as to realize a simple browser features. Using xml browser, customers can achieve the personalized features, such as weather information, stock information, date of inquiry, access to address book, google search, news browsing, playing music, configuration of the terminal parameters and other functions.

To assign the key as Xml Browser:

- 1) Choose Phone->DSS Key-> Line Key, choose one of the keys you want to make the assignment, there is a pull-down menu in the Type field, choose Xml Browser from

the list.

- 2) Enter the URL address you want to connect to in the Value field.
- 3) Press Confirm button to save the changes.

## **Hot Desking**

Hot desking is regularly used in places where not all the employees are in the office at the same time, or not in the office for very long at all, which means actual personal offices would be often vacant, consuming valuable space and resources.

Hot desking is a phone feature that allows accounts to login or logout in an IP phone. After a certain account landing, the corresponding configuration of the account will be applied to the phone.

This IP phone can support two kinds of Hot desking: Base Mode and Advanced Mode.

- Base Mode: Pressing the DSS key which is set to be Hot Desking when the phone is idle to active the Base Mode. By this mode, it will clear all of the account records, then set up an account and register for the first account.
- Advanced Mode: By this mode, it will clear the first account information, then connect the URL to download the Xml file and configure a new account.

To assign the key as Hot Desking:

- 1) Choose Phone->DSS Key-> Line Key, choose one of the keys you want to make the assignment, there is a pull-down menu in the Type field, choose Hot Desking option from the list.
- 2) In the "Value" field, enter the URL address in the input field to active the advanced mode. Or you can leave it blank to active the base mode.
- 3) Press Confirm button to save the changes.

## **URL Record**

During the conversation, pressing the type of DSS key, and then follow the voice prompts to achieve the call recording capability.

- 1) When you are on the conversation, pressing the DSS key to start the recording process in the current Call.
- 2) Enable the recording function, the recording icon will be flashing for the ongoing recording process.
- 3) Pressing the DSS key again to disable the recording function, and the flashing recording icon will be disappeared simultaneously.
- 4) Follow the voice prompts to listen to the recording.

To assign a DSS key as URL Recorder:

- 3) Choose Phone->DSS Key-> Line Key, choose one of the keys you want to make the assignment, there is a pull-down menu in the Type field, choose URL Recorder from the list.
- 4) Enter the condition code in the Value field.
- 5) Press Confirm button to save the changes.

**Note:**

During a conversation, press this type of DSS key to start the recording process; if the other party hung up, your phone will turn to the idle status.

## LDAP

If you want to use the LDAP function, you must configure the corresponding options in the LDAP interface at first.

To assign the key as LDAP:

- 1) Choose Phone->DSS Key-> Line Key, choose one of the keys you want to make the assignment, there is a pull-down menu in the Type field, choose LDAP from the list.
- 2) Press Confirm button to save the changes.
- 3) When you press this key under the idle, the phone will turn to the contact search interface.

## BLF List

BLF list is a function which can monitor the group status, it is not one to one monitoring, but the information feedback from the sever to decide which BLF list will monitor which account.

To set BLF List via web interface:

- 1) Choose Account->Advanced-> BLF List URI, enter the BLF List URI.
- 2) Then enter the BLF List Code in the BLF List Code field.
- 3) Click the Confirm button to save.

To assign the key as BLF List:

- 1) Choose Phone->DSS Key-> Line Key, choose one of the keys you want to make the assignment, there is a pull-down menu in the Type field, and choose BLF List from the list.
- 2) In the "Line" field, select a line for which to apply this key.
- 3) Press Confirm button to save the changes.

## Prefix

When you set up the function of prefix, press this key, the phone will be ready to make a new call, and show up the content which your set previously on the dial interface. And you could enter other figure and call out

To assign the key as Prefix:

- 1) Choose Phone->DSS Key-> Line Key, choose one of the keys you want to make the assignment, there is a pull-down menu in the Type field, and choose Prefix from the list, and enter the number you want to show up on the dial interface in the Value field.



- 2) Press Confirm button to save the changes

## **Zero-sp-touch**

You can also press the DSSKey which set as the Zero-sp-touch. Then press the DSSKey, the phone will turn to the Zero-sp-touch interface.

To assign the key as Zero-sp-touch:

- 1) Choose Phone->DSS Key-> Line Key, choose one of the keys you want to make the assignment, there is a pull-down menu in the Type field, and choose Zero-sp-touch from the list.
- 2) Press Confirm button to save the changes

## **ACD**

ACD(Automatic Call Distribution) is automatic call distribution equipment, is according specific Transfer Rules and distribution strategy to switch the access call to the right person.

Presses DSSKey, it will pop up a login box, enter the User ID and Password, click the Log In hot key.

Presses DSSKEY again enter to the ACD Status page, choose Available/Unavail to change the status.

You can also press LogOut hot key to logout.

When you status is Available, the calls will be directed to your phone. Or the status is unavailable, the calls will not be directed to your phone.

To assign the key as ACD:

- 1) Choose Phone->DSS Key-> Line Key, choose one of the keys you want to make the assignment, there is a pull-down menu in the Type field, and choose ACD from the list.
- 2) In the "Line" field, select a line for which to apply this key.
- 3) Press Confirm button to save the changes

**Note:**

ACD is not available on all call servers. For more information, contact your system administrator.

## **Local Group**

The keys can be configured as Local Group key. Then pressing this key under the idle status, you can enter the Local Group interface.

To assign the key as Local Group:

- 1) Choose Phone->DSS Key->Line Key, choose one of the keys you want to make the assignment, there is a pull-down menu in the Type field, choose Local Group from the list.
- 2) In the Line field, choose a group.
- 3) Press Confirm button to save the changes.

## **Broadsoft Group**

The keys can be configured as Broadsoft Group. Then pressing this key under the idle status, you can enter the Broadsoft Group interface.

To assign the key as Broadsoft Group:

- 1) Choose Phone->DSS Key->Line Key, choose one of the keys you want to make the assignment, there is a pull-down menu in the Type field, choose Broadsoft Group from the list.
- 2) In the Line field, choose a broadsoft Group to specify the record, so you must configure the Broadsoft Group at first.
- 3) Press Confirm button to save the changes.

## **Tone Settings**

You can define the frequency and time period of all the following tones:

- Dial
- Ring Back
- Busy
- Congestion
- Call Waiting
- Dial Recall
- Record
- Info
- Stutter
- Message
- Auto Answer

To edit the tone filed via Web interface:

- 1) Choose Phone->Tones.
- 2) Enter the frequency and time period(in ms) as the following format:  
Frequency /Time Period (for example 400/200).
- 3) Press Confirm button to save the changes, Cancel to cancel the change.

**Note:**

1. Please contact your system administrator for more information about the

- frequency and time period parameters. You can enter up to 8 groups for each tone.
2. If the frequency is set as 0, it means silence.

## Voice

To edit the Voice filed via Web interface:

- 1) Choose Phone->Voice.
- 2) Set the following parameters shown in the table.

Parameter	Description
<i>Echo canceller</i>	Defines whether to enable the echo canceller.
<i>VAD</i>	Voice activity detection (VAD), also known as speech activity detection or speech detection, is a technique used in speech processing in which the presence or absence of human speech is detected.
<i>CNG</i>	A comfort noise generator (CNG) is a program used to generate background noise for voice communications during periods of silence that occur during the course of conversation.
<i>JITTER BUFFER</i>	It is a shared data area where voice packets can be collected, stored, and sent to the voice processor in evenly.
<i>Type</i>	To choose the type of JITTER BUFFER, adaptive or Fixed.
<i>Delay</i>	To set the Min Delay, Max Delay and Normal Delay parameter.

The screenshot shows the Yealink web interface for configuring voice settings. The 'Phone' tab is selected, and the 'Voice' sub-tab is active. The configuration is divided into two main sections: 'Echo Cancellation' and 'JITTER BUFFER'. In the 'Echo Cancellation' section, 'Echo canceller' is set to 'Enabled', 'VAD' is set to 'Disabled', and 'CNG' is set to 'Enabled'. In the 'JITTER BUFFER' section, 'Type' is set to 'Adaptive', 'Min Delay' is '0', 'Max Delay' is '300', and 'Normal Delay' is '120'. A 'NOTE' section on the right provides definitions for VAD, CNG, and JITTER BUFFER. 'Confirm' and 'Cancel' buttons are located at the bottom of the configuration area.

- 3) Press Confirm button to save the changes, Cancel to cancel the changes.

## Ring

Users can group your contacts, and then set the ringing tone for each group.

To edit the Ring option via Web interface:

1) Choose Phone->Ring.

ID	Internal Ringer Text	Internal Ringer File
1	<input type="text"/>	Ring1.wav
2	<input type="text"/>	Ring1.wav
3	<input type="text"/>	Ring1.wav
4	<input type="text"/>	Ring1.wav
5	<input type="text"/>	Ring1.wav
6	<input type="text"/>	Ring1.wav
7	<input type="text"/>	Ring1.wav
8	<input type="text"/>	Ring1.wav
9	<input type="text"/>	Ring1.wav
10	<input type="text"/>	Ring1.wav

2) Internal Ringer Text: To set group name. For example, family.

3) Internal Ringer File: To choose a special ring tone for the group.

4) Click the Confirm button to save the changes.

# Trouble Shooting

## **I can not register to the server?**

- 1) Check the IP address. If you set your WAN port in DHCP mode, please make sure that your DHCP server is on.
- 2) Check your gateway.
- 3) Check your DNS server.
- 4) Make sure your account information is the same as you have got from your ISP.
- 5) Check whether the SIP server is on.
- 6) Check the SIP register port, the default value is 5060.

## **I can't get the IP address?**

- 1) Make sure you have plugged the Ethernet cable into the WAN port.
- 2) Make sure that the DHCP server is on, and there are available IP addresses in the server.
- 3) Try to set your WAN port to static IP client mode.

## **During a call, I can not hear any voice?**

- 1) Make sure your handset is tightly connected with the phone.
- 2) Check whether you have muted the conversation or not.
- 3) Consult the outbound server details with your ISP.

## **Have DTMF problem?**

- 1) Check which kind of DTMF you are using, and whether it is compatible with the server.
- 2) Consult the payload value with your ISP.

## **How to change the time?**

Select the time zone or enter the time information manually on the webpage or the phone.

## **How to answer the incoming calls during a call?**

If a call comes in when you are in a conversation, press the Answer hot key to answer the call, or press the Reject hot key to refuse it.

## **How to refuse incoming calls during a call?**

You can turn off the function of call waiting, and then our phone will refuse all the

incoming calls when you are in a conversation.

**How to send SMS?**

You could edit the SMS in the Menu-> Messages->Text Messages.

**Note:**

Make sure that the SIP server you have registered supports SMS function.

**How to update the firmware?**

- 1) Enter the webpage of your phone, go to Upgrade, then you can find the option "Select and Upgrade Firmware" at the bottom of the page.
- 2) Select the file to update, then click the Upgrade button.

**Note:**

Make sure the firmware you choose is provided by your service provider, or the device will probably crash after the update.

**How to auto provision?**

Consult the auto provision server address with your ISP.

The manual is only for reference; please take the object as the standard.

We reserve the right to improve or change the product and the user guide without notice.

You can download the latest user manuals from our website:

<http://www.yealink.com/en/download.asp?BigClassName=IP%20Phone>